

THE RADIO REVIEW

A MONTHLY RECORD OF SCIENTIFIC
PROGRESS IN RADIOTELEGRAPHY
AND TELEPHONY

VOL. II MARCH, 1921 No. 3

Editor :
PROFESSOR G. W. O. HOWE, D.Sc., M.I.E.E.

Assistant Editor :
PHILIP R. COURSEY, B.Sc., A.M.I.E.E.

CONTENTS

- The Effect of Impurities on the Ionisation Potentials Measured in Thermionic Valves L. S. PALMER, M.Sc.
- The Paris Radio Central
- A Note on the Theory of the Thermionic Tube
J. A. FLEMING, M.A., D.Sc., F.R.S.
- Editorial Note
- Measurements of Radiation of Radiotelegraphic Aerials
G. VALLAURI
- The Effect of Modulation Waveshape upon Received Signals
A. S. BLATTERMAN
- The Physical Society's Exhibition
- Notes—Personal, Commercial, Legal, General
- Review of Radio Literature :—
 - Abstracts of Articles and Patents
 - Books Received
- Correspondence

Two Shillings and Sixpence Net

THE RADIO REVIEW

A MONTHLY RECORD OF SCIENTIFIC PROGRESS IN
RADIOTELEGRAPHY AND TELEPHONY

Editor: Prof. G. W. O. HOWE, D.Sc., M.I.E.E. Asst. Editor: PHILIP R. COURSEY, B.Sc., A.M.I.E.E.

SUBSCRIPTION RATES.—30/- per annum, post free. Single copies, 2/6, or post free, 2/9.

Vol. II. No. 3

Registered at the G.P.O. for transmission by
Magazine Post to Canada and
Newfoundland.

MARCH, 1921

Contents

	PAGE
THE EFFECT OF IMPURITIES ON THE IONISATION POTENTIALS MEASURED IN THERMIONIC VALVES. By L. S. PALMER, M.Sc.	113
THE PARIS RADIO CENTRAL	125
A NOTE ON THE THEORY OF THE THERMIONIC TUBE. By J. A. FLEMING, M.A., D.Sc., F.R.S.	133
EDITORIAL NOTE	136
MEASUREMENTS OF RADIATION OF RADIOTELEGRAPHIC AERIALS. By G. VALLAURI .	138
THE EFFECT OF MODULATION WAVESHAPES UPON RECEIVED SIGNALS. By A. S. BLATTERMAN	144
THE PHYSICAL SOCIETY'S EXHIBITION	152
NOTES :—	
Personal	152
Commercial	152
Legal	154
General	155
REVIEW OF RADIO LITERATURE :—	
Abstracts of Articles and Patents	156
Books Received	164
CORRESPONDENCE :—	
Norman Lea on "Inductance Calculations"	165
W. J. Henry on "Mica Condensers for Radio Work"	166

BINDING CASES FOR VOL. I.
of
THE RADIO REVIEW

Are now in course of preparation. Superior Quality, maroon cloth, lettered in gilt on back, ornamental side.

Price **5/-** net (including full Index). Post free **5/4**

INDEX supplied separately. 1/- post free

THE RADIO REVIEW, VOL. I.

bound complete in case as mentioned above.

Price **£2 2 0** net. Post free **£2 3 0**

ORDER FORM.

To The Wireless Press, Ltd.,
12-13, Henrietta St.,
Strand, London, W.C. 2.

Please send BINDING CASE
 INDEX THE RADIO REVIEW,
 BOUND VOLUME I.
(Delete line which does not apply.)

for which I enclose remittance value

Name.....

Full Postal Address.....

Date.....1921

THE RADIO REVIEW

VOL. II

MARCH, 1921

NO. 3

The Effect of Impurities on the Ionisation Potentials Measured in Thermionic Valves.*

By L. S. PALMER, M.Sc.

1. Introduction.

The following work was undertaken with the object of determining the causes of the low value obtained for the ionisation potential of helium by a valve method recently described in the RADIO REVIEW † by Dr. Hodgson in conjunction with the author. Since the publication of this paper Stead and Gossling ‡ have, by a different valve method, obtained a similarly low value. They also obtained a value of 12·5 volts for the ionising potential of argon, which value is 4·1 volts less than that obtained by Hodgson and Palmer in the work previously mentioned.

Professor Horton and Miss Bailey § have shown that the addition of a trace of mercury vapour to helium is sufficient to cause ionisation phenomena at voltages varying from about 20 to 25, but that true ionisation of the helium does not occur with voltages less than 25. These effects were accounted for by the fact that "20·5 volt" radiation of helium can ionise the impurities of low ionisation potential that may be present in the tube. ||

This explanation is possible since ionisation of a given atom occurs when sufficient energy is absorbed to cause the removal of one or more of the constituent electrons of the atom. Ionisation can be caused by the bombardment of the atom by an electron whose energy (by virtue of its velocity) is sufficient to cause the removal of one or more electrons from the sphere of influence of the positive atomic nucleus. The ionisation potential is that difference of potential through which an electron must fall before it acquires this critical velocity.

The resonance potential is that voltage fall which will give an electron just sufficient energy to displace one of the constituent electrons of an atom from one orbit to another, but is insufficient to remove the electron completely, that is, is insufficient to cause ionisation. Bohr has pointed out that ionisation can occur if the gas atom absorbs sufficient energy from other

* Received November 3rd, and in final form November 18th, 1920.

† Hodgson and Palmer, RADIO REVIEW, 1, p. 525, August, 1920.

‡ *Philosophical Magazine*, 40, p. 413, October, 1920.

§ *Philosophical Magazine*, 40, p. 440, October, 1920.

|| Bohr, *Philosophical Magazine*, 30, p. 410, 1915.

sources other than from a moving electron. In particular, ultra-violet light of sufficiently high a frequency may cause ionisation.

Resonance is accompanied by the emission of radiation in the form of ultra-violet light. If the energy necessary for "resonance impact" of one atom is greater than the energy necessary for the ionisation of another atom, then the resulting ultra-violet light from the first atom may cause ionisation of the second. Thus, since the resonance potential of helium is 20.5 volts, the resulting ultra-violet light will have a sufficiently high frequency to cause ionisation of (say) mercury vapour, the ionisation potential of which is only 10.5 volts. Since the resonance potential of argon is 12.5 volts which is greater than the ionisation potential of mercury, it was thought that this explanation may also account for the different values for the ionisation potential of argon quoted above.

Again Bohr has shown* that ionisation should occur more readily in the case of an atom which has already absorbed sufficient energy to cause it to resonate, that is the critical ionisation potential for unstable or resonated atoms will be less than the ionisation potential necessary for stable or normal atoms (see p. 120).

2. Method.

The method of investigation was similar to that previously used by the author and described in the paper referred to above. Three-electrode thermionic valves were employed in which the plate potential (V) was varied,

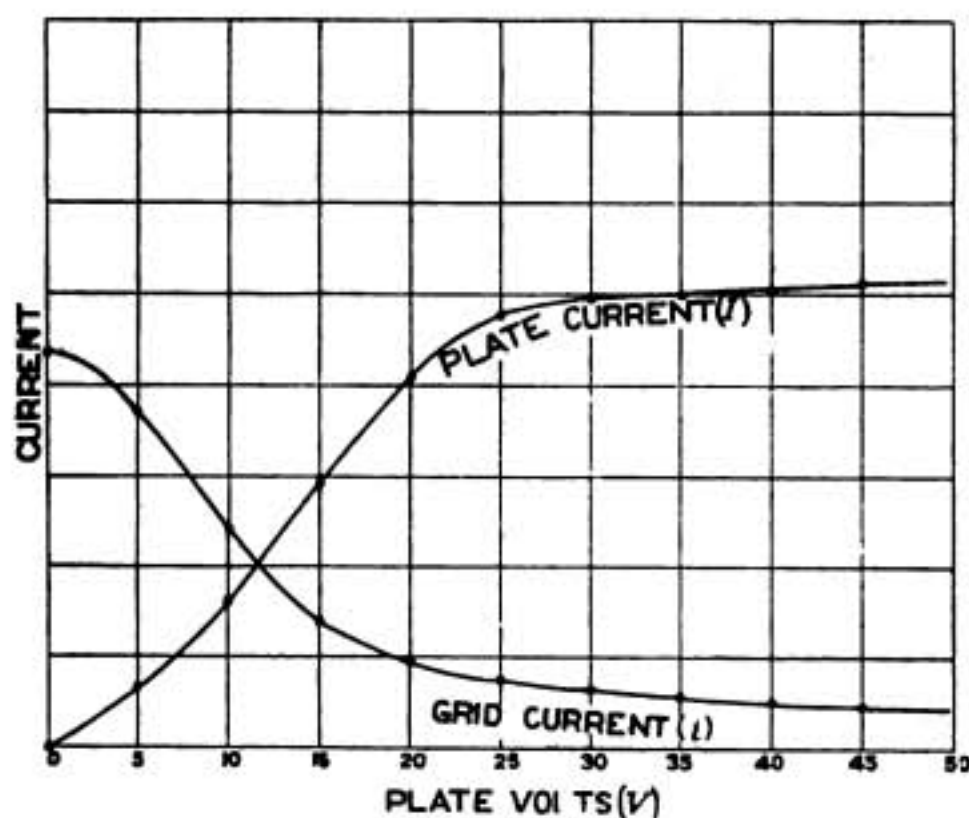

FIG. 1. Hard Valve.

in order to control the grid current (i) and the plate current (I). The grid was kept at some constant positive potential (v). The (i, V) characteristic and the (I, V) characteristic for a hard valve are shown in Fig. 1.

* *Philosophical Magazine*, 30, p. 410, 1915.

With a soft valve the curves bend up at the points B and B' of Fig. 2, due to the extra electrons produced by bombardment of the filament by positive ions. The corrected value of V' was taken to be the ionisation potential of the gas present in the valve. In the case of helium the value thus obtained was 21.9 volts.

There is some independent evidence, about to be published, which tends to show that the valve used also contained a trace of mercury. Assuming the bend in the (i, V) characteristic of the helium valve to be due to ionisation of the mercury vapour by the "20.5 volt" radiation of helium, it was to be expected that a further change in the slope of the characteristic would occur in the neighbourhood of 25—26 volts. This was concluded because if ionisation of the helium atom occurred by impact with an electron whose

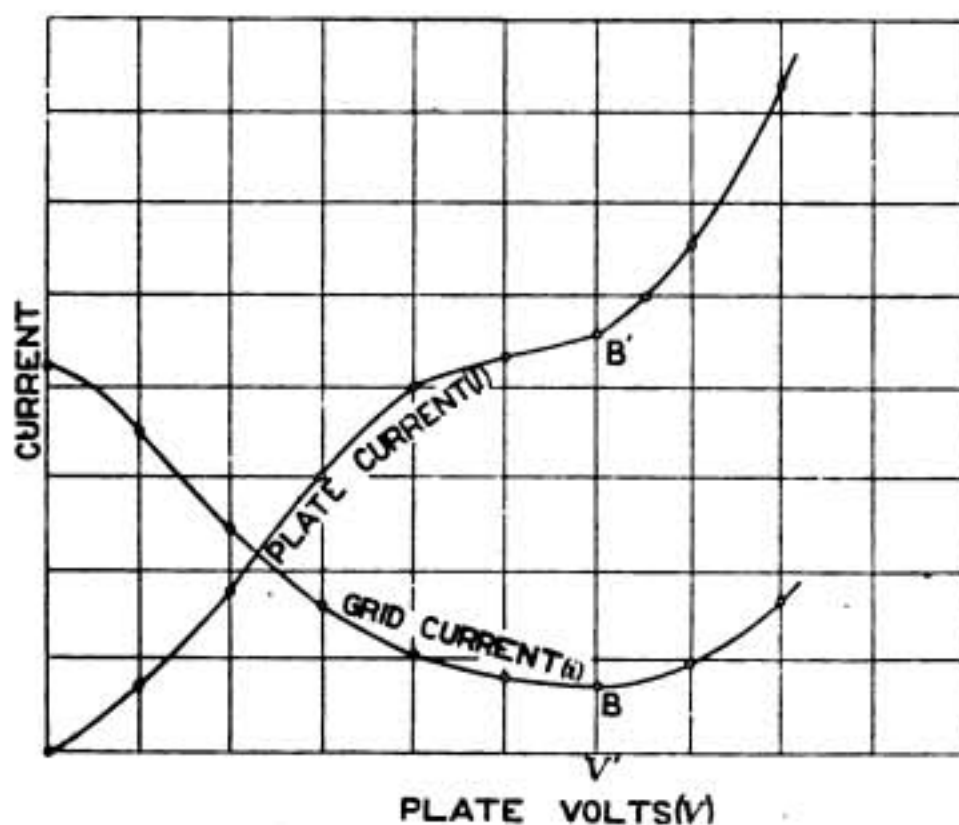

FIG. 2.—Soft Valve.

energy was that obtained by falling through a potential gradient of 25.6 volts (Horton's result) then at this value of the plate potential an increased number of electrons and positive ions would be produced by the ionisation of the helium atoms. This augmentation of the number of current carriers would increase the slope of the characteristics at the point where ionisation first set in, that is when the corrected plate potential is about 25.6. To test this the (i, V) characteristic was obtained from $V = 0$ to $V = 50$ volts.

3. Results with Helium Valve.

A set of characteristics with varying filament volts (v_f) are shown in Fig. 3. They were obtained with the R 2 A valve used in the previous work. The (I, V) characteristic for $v = 3.4$ volts is shown on the same scale. The following points are of interest:—

At A ($V = 10$) there is a suggestion of a deviation which is just noticeable

with high filament temperatures; the similarity in the change in both the grid and plate current curves possibly denotes a very slight abnormal increase in the electron current to both the grid and the plate.

At B ($V = 21$) a more marked change in the current values occurs. In this case the grid current (i) commences to increase.

Between 25 and 26 volts—point C—a rapid rise in both currents takes place and continues until the plate volts (V) attain a value of 30.

At this point D, the grid current again commences to decrease; the change being quite sudden with high filament temperatures. The steady decrease continues until the current is zero and then changes sign. Mean-

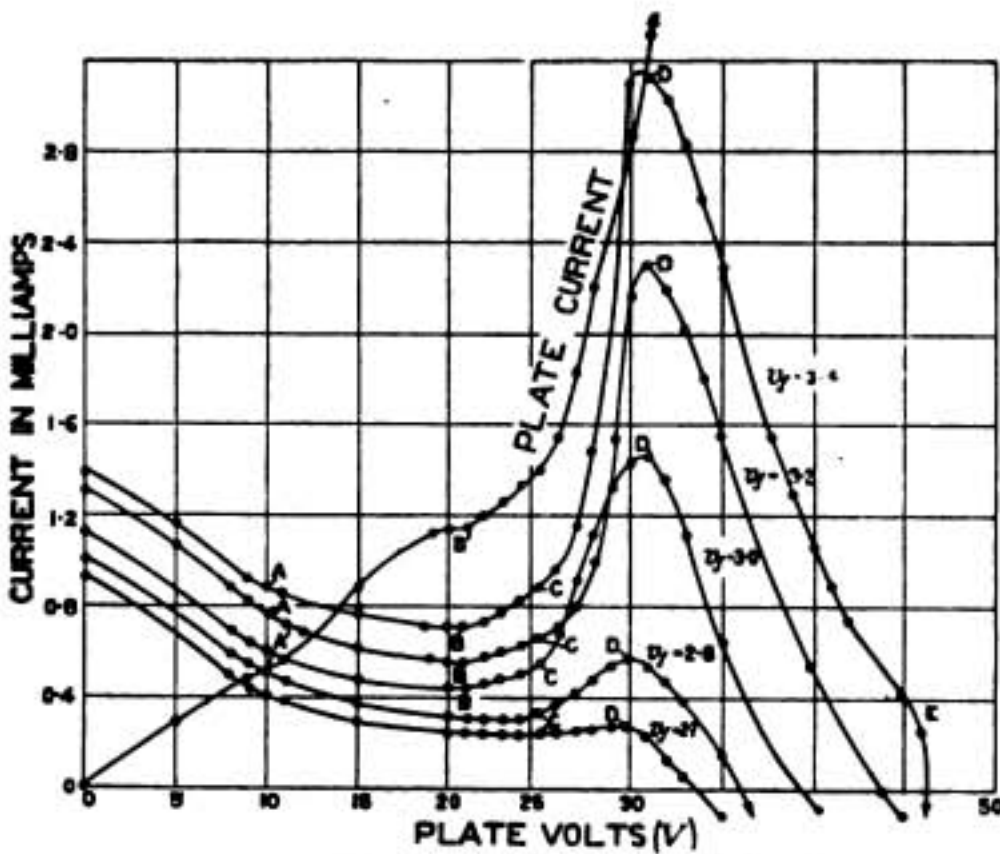

FIG. 3.—R 2 A (He) Valve. $v_f = 8.0$ volts.

while the plate current steadily increases but at a much greater rate than previously.

The point E ($V = 45$) was only noticeable at filament voltages about 3.4, for which values of v_f the grid current did not change sign at plate voltages less than 45.

Reference to Fig. 3 shows that as the filament temperature was decreased the curves were considerably modified.

It may also be mentioned that a reduction of the grid voltage produced similar modifications; for example, the characteristic for zero grid volts is comparable to that for which $v_f = 2.7$ in Fig. 3.

It is interesting to note that Professor Horton and Miss Bailey when using helium contaminated with mercury obtained a sudden increase in current at about 30 volts which they describe as an abrupt increase "at an electron velocity a few volts above that at which ionisation of the helium can occur."

TABLE I.

Point.	$(V + E - v_f/2)$ Volts.					Mean.
	$v_f = 2.7$	2.8	3.0	3.2	3.4	
A	—	—	—	10.8	10.0	10.4
B	—	?	20.3	21.0	21.0	20.7
C	?	24.8	25.2	26.3	25.8	25.5
D	30.0	30.0	30.8	30.8	30.3	30.4
E	—	—	—	—	45.8	45.8

The curves of Fig. 3 tend to show that this is an effect occurring in addition to the ionisation of helium, which causes a separate change in curvature at point C. In other words, since there are two distinct changes in the slope of the same characteristic, there must be two independent phenomena producing these changes. (See also p. 122.)

The value of the plate potential (V) for the various critical points does not give the true voltage fall through which an electron passes in travelling from the filament to the plate. A more exact expression is:—

$$V + E - v_f/2$$

where E is the emission velocity in equivalent volts with which an electron leaves the filament and v_f is the voltage fall along the straight filament. The correction $(E - v_f/2)$ has been found* to be approximately constant and for the R 2 A valve in use was equal to -0.2 of a volt.

The corrected values for the potentials of the various critical points in the (i, V) characteristics of the helium valve are given in Table I.

These curves were repeated for a different R 2 A valve in which it was possible to raise the filament volts to 5.8. The following modifications were noticed and are shown on Fig. 4.

(1) Five critical points were obtained, namely at corrected plate potentials of 15.2, 19.8, 25.1, 54.5 and 80.5 volts. The

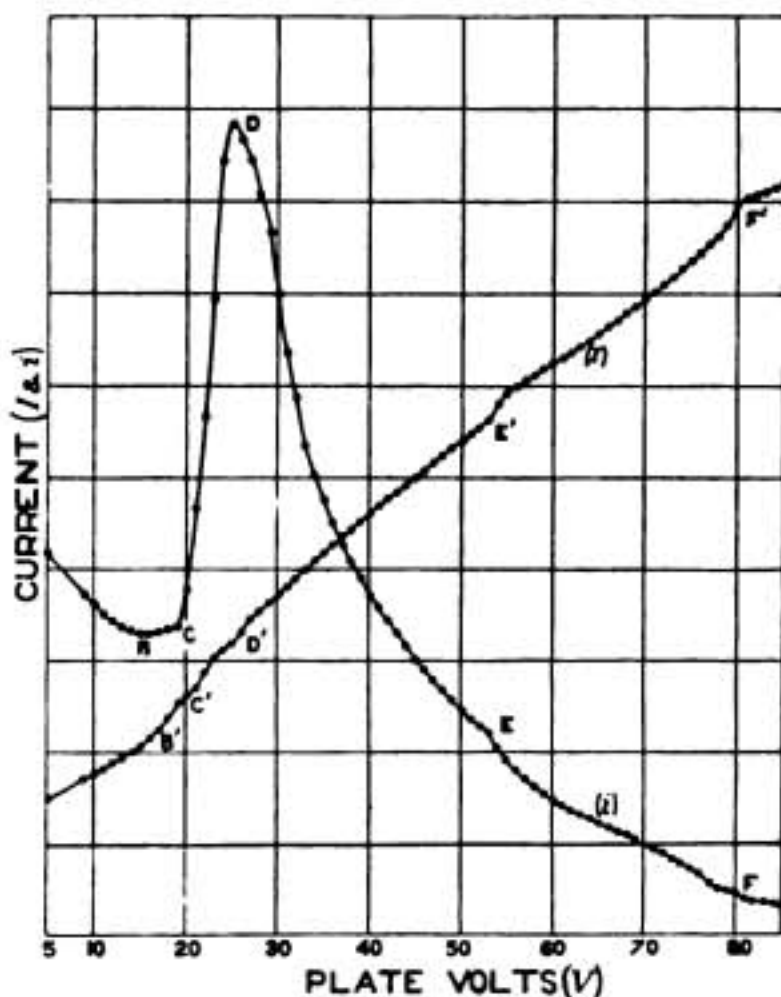

FIG. 4.—R 2 A (He) Valve. $v = 8.0$ volts.
 $v_f = 5.8$ volts.

* Hodgson and Palmer, *loc. cit.*

same correction was used as before, namely $(E - v_f/2)$ but owing to the high filament temperature it is certain that electrons with the requisite energy were emitted in considerable numbers from points much nearer to the comparatively cold filament supports, in which case $v_f/2$ is too large a deduction. This is probably the reason why the above values, which correspond to critical potentials previously obtained, are somewhat lower.

(2) The last point was obtained below the plate voltage axis.

(3) The discontinuities at 54.5 and 80.5 were extremely small compared with the effects at 19.8 and 25.1; the latter point in particular being a high peak of type D (Fig. 3).

The results are tabulated below; the letter indicating the type of bend as in Fig. 3.

TABLE II.

Point.	$(V + E - v_f/2)$ Volts.
A	—
B	15.2
C	19.8
D	25.1
E	54.5
F	80.5

The change in curvature about 30 volts may be a further effect corresponding to the point D of Fig. 3, but there is no apparent discontinuity in the characteristic.

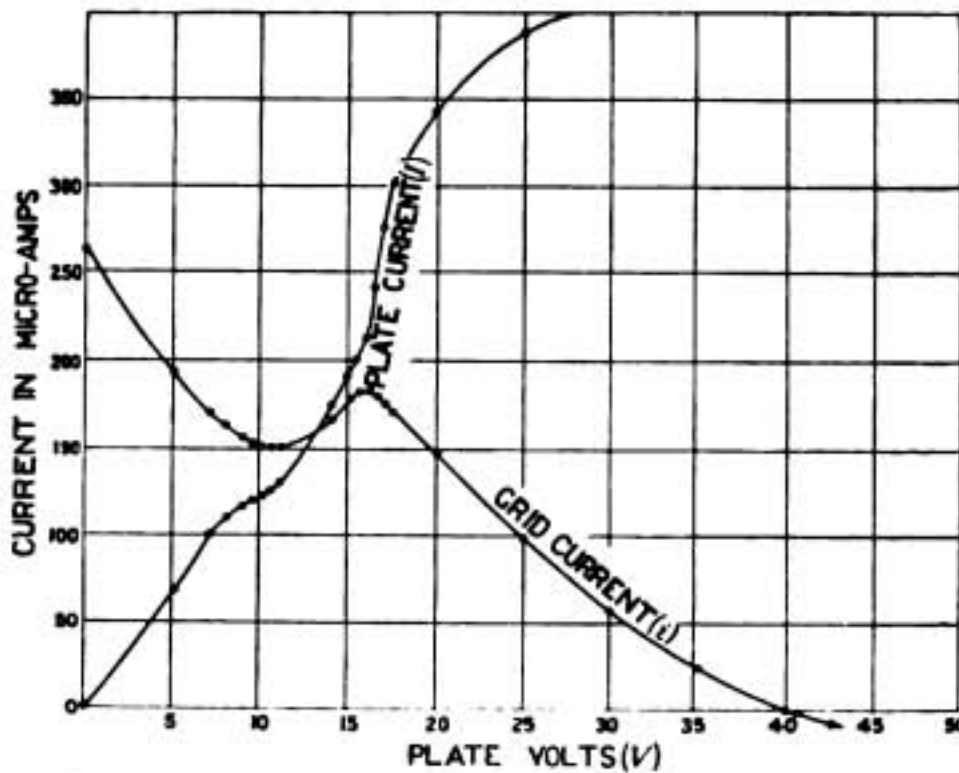

FIG. 5.—N. P. L. No. 2 (Hg) Valve. $v_f = 3.2$ volts.
 $v = 8.0$ volts.
 $E = 2.0$ volts.

4. Results with Mercury Valve.

Fig. 5 shows the characteristics obtained from an N. P. L. No. 2 valve which contains an amalgamated silver plate. Using the same lettering as in the previous table for similar types of change in the characteristic slope, the corrected values of the corresponding plate potentials are given in Table III.

TABLE III.

Point.	$(V + E - v_f/2)$ Volts.
A	—
B	10.9
C	—
D	15.4
E	—

5. Results with Argon Valve.

The set of characteristics shown on Fig. 6 were obtained by varying the relative pressures of a mixture of argon and mercury vapour. The filament temperature and grid volts were kept constant throughout, although three different valves of similar geometry had to be used owing to the rapid disintegration of the filament under the bombardment of the argon ions. The Curves I., II. and III. (Fig. 6) were obtained with one valve, Curves IV. and V. with a second, and Curve VI. with the third valve.

To obtain Curve I. precautions were taken to freeze out all mercury vapour, whilst the electrodes were bombarded during evacuation to rid them

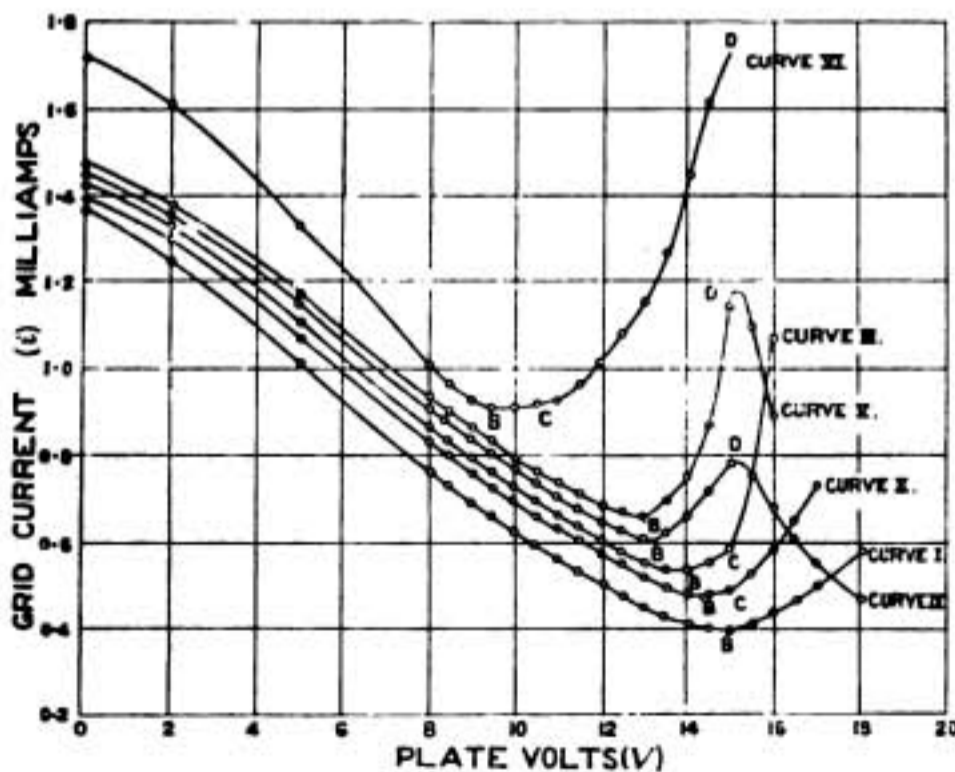

FIG. 6.—R (A + Hg) Valve. $v = 3.2$ volts.
 $v = 8.0$ volts.
 $E = 3.1$ volts.

of occluded gas. With Curves II. to VI. the mercury vapour pressure was progressively increased and argon added from a side tube till the total pressure was about .04 mm. of mercury in each case.

Curve I. is similar to that obtained when previously determining the ionising potential of argon. Curves II., III., IV. and V., show the plate potential of the bend B gradually approaching a value of 13.0 volts as the impurity (mercury vapour) is increased.

With Curves II. and III. the bend C occurs at the same plate voltage as point B of Curve I. whilst with Curves IV. and V. and probably VI. the bend D occurs at this particular value of the plate potential.

With Curve VI., for which the argon may be looked upon as an impurity in a mercury valve, the curve is similar to that of Fig. 5 with an additional bend at about 11 plate volts. (See paragraph 6.)

For these valves the value of the plate potential correction was about + 1.5 volts but varied slightly with the different valves. Table IV. gives the corrected plate potentials for the various critical points which have been lettered in the same manner as the curves of Fig. 3. From this table it can be seen that

TABLE IV.

Point.	$(v + E - v_p/2)$ Volts.					
	Curve I.	Curve II.	Curve III.	Curve IV.	Curve V.	Curve VI.
A	—	—	—	—	—	—
B	16.5	15.7	15.5	14.5	14.3	10.7
C	—	16.5	16.5	—	—	12.5
D	—	—	—	16.5	16.7	16.5
E	—	—	—	—	—	—

the corrected value of the plate potential for the point B gradually decreases from 16.5 volts in Curve I. to 14.3 volts in Curve V. Thus, if as was assumed in the previous paper (*loc. cit.*), this bend be taken to indicate the ionisation potential of argon, the value obtained will be subject to a variation ranging from 16.5 volts to a value which apparently approaches 12.5 volts; that is from the true ionisation potential of argon to its resonance potential. But the dependence of this variation upon the amount of impurity present is in accordance with Horton's results in helium, which he explained by Bohr's statement that the radiation from such a gas will be capable of ionising any impurity, the ionising potential of which is less than the resonance potential of the chief gaseous constituent.* A similar explanation can therefore be applied to account for the above results and probably explains the low value of the ionising potential of argon recorded by Stead and Gossling.

On the other hand, if the atom is more readily ionised after it has absorbed the energy radiated from an adjacent atom (see p. 114) an increase in total pressure (*i.e.*, in the number of atoms present) should increase the radiation

* See p. 114.

in the tube and hence the probability of ionisation occurring would also be increased. This effect would be independent of the presence of impurities. To test this, Curve I. of Fig. 6 was reproduced with argon at pressures of 0.10 mm, 0.07 mm and 0.01 mm of mercury (Fig. 7). The same precautions were taken to freeze out mercury vapour. The curves show a slight reduction in the value of the point B: the critical potentials being 15.8, 16.3 and 16.6 respectively. Although the effect is smaller than that produced by the addition of impurities, it tends to show that ionisation of unstable atoms (*i.e.* of atoms which have absorbed radiation from neighbouring atoms which have been previously impacted) is taking place, causing a reduction in the usual ionisation potential observed at low pressures.

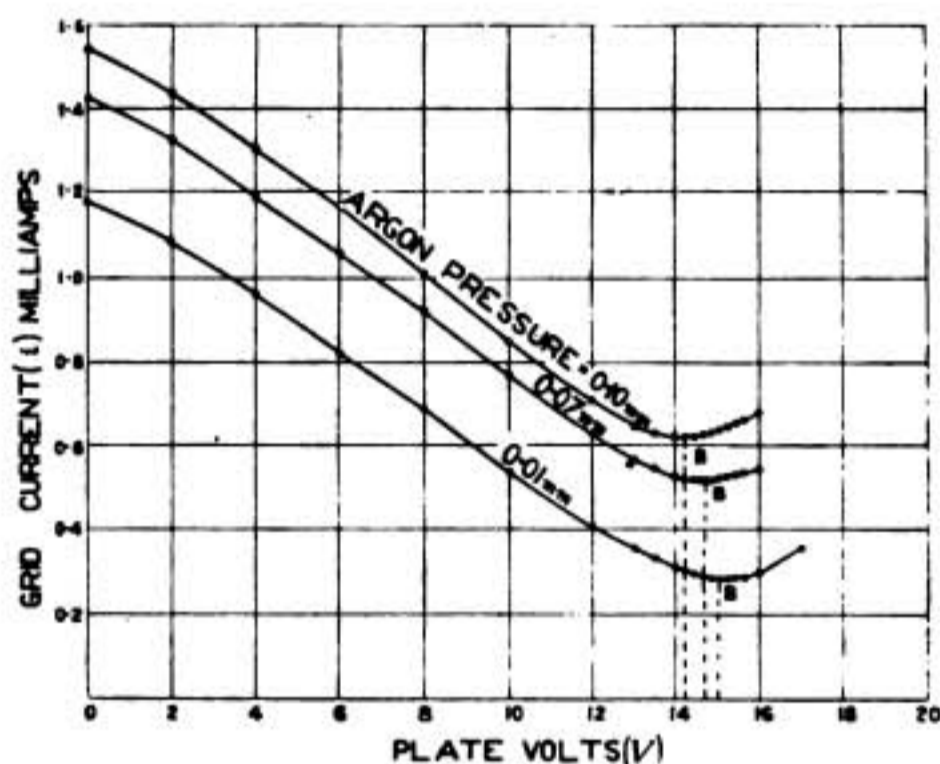

FIG. 7.—R (A) Valve.
 $v = 8.0$ volts.
 $v_f = 3.2$ volts.
 $E = 3.2$ volts.

Pressure in mm of Hg.	Critical Potential.	
	From Graph.	Corrected.
0.10	14.2	15.8
0.07	14.7	16.3
0.01	15.0	16.6

6. Discussion.

Whatever physical phenomena are occurring in the valves at the various critical points, it is of importance to note that each change of grid current is accompanied by an increased current to the plate (see Figs. 3 and 5). In no case does the plate current decrease. The same effect is seen in the grid current for the bends of type A, B and C. Types D and E are abnormal decreases in grid current.

The increases in the plate current may be accounted for by either:—

- an increased number of electrons arriving at the plate, or
- an increased number of positive ions leaving the plate.

Horton* has shown that the latter effect can take place under the bombardment of electrons but such an explanation is precluded in the present case by the regularity of the plate current characteristic of a hard valve (Fig. 1). We are thus left with the first possibility. If ionisation is occurring in the tube the bombardment of the filament by the resulting positive ions will cause an abnormal increase in the filament emission and consequently an abnormal increase in the plate current. Since ionisation can occur at the critical points A, B and C, it is probable that the foregoing explanation accounts for these particular changes of characteristic slope and that these critical points are therefore due to ionisation. The corresponding points in the grid current curve can be explained in the same way; although, if the ionisation is occurring between the grid and the plate, a certain percentage of the positive ions will also be collected by the grid.

It is therefore conceivable that, should sufficient positives be produced between the grid and the plate, the grid current will be considerably reduced or even reversed. Such an occurrence will explain the critical points D and E and the decreasing grid current will be the result of an ever increasing number of positive ions being collected by the grid. At the point where the grid current curve crosses the plate voltage axis the number of electrons and positive ions arriving at the grid from opposite directions will be equal. Since a bend of type D can occur when $V = 16.5$ volts in argon (Curves IV. and V. of Fig. 6), and a similar effect has been obtained in helium at 25.5 volts (Fig. 4), at which potentials ionisation is known to take place, the above explanation is all the more probable.

Again since the point D, from this standpoint, depends upon the relative number of electrons and positive ions arriving at the grid, there is no particular reason why the change in direction should not occur at any critical voltage at which an increase in ionisation occurs.

Thus the occurrence of the point D at 30.4 volts in helium may indicate a sudden increase in the ionisation at this potential. Horton found a sudden increase at this potential whilst from Bohr's theory ionisation is to be expected at 29.4 volts. On the other hand the value 30.4 is approximately the sum of the ionisation potential of mercury and the resonance potential of helium. In other words, it is possible for one electron to cause ionisation of the mercury vapour by direct impact and also to gain sufficient energy to ionise indirectly by causing the emission of ultra violet light from the helium atom, before the electron reaches the anode.

Again 30.4 volts is exactly double 15.2 volts at which potential critical points were obtained in both helium and mercury valves (Figs. 4 and 5). Hence the discontinuity at 30.4 may be due to the presence of carbon monoxide or water vapour, the ionising potentials of which are about 15 volts. Such gases may easily be present in these valves, and their presence has been detected by Stead and Gossling† in valves not nominally containing either carbon compounds or water vapour.

* *Proceedings of the Royal Society*, 95A, p. 408, 1919.

† *Philosophical Magazine*, 40, p. 421, October, 1920.

A similar effect, if due to the presence of both mercury and helium might be expected at $(10.4 + 25.5)$ volts; but no such critical point could be detected. This makes it more probable that the bend at 30.4 volts is either that predicted by Bohr and is therefore due to further ionisation of helium or is due to the presence of other impurities (see below).

Point E ($V = 45.8$) is particularly interesting as this confirms the work of Professor Horton and Miss Davies* in which they obtained a critical value at about 47 volts. In their opinion such a point arises from a second radiation potential, the theoretical value of which is $(20.4 + 25.6)$ volts.

Finally, if the slight change in curvature at the point where $V = 40-41$ is a real effect, it can be accounted for either by the (20.4×2) volt radiation which must occur here, or by the radiation from the helium atom which has lost one electron. Bohr's theory gives a value of 40.6 volts for radiation from a charged helium atom.

Whatever may be the explanation of the points D and E, the changes at B and C enable the ordinary resonance and ionisation potentials of impure gases to be determined, whilst for a pure gas point B gives the first true ionisation potential.

Under certain conditions the point D will record the ionisation potential as in Fig. 4 and in Curves IV. and V. of Fig. 6.

From Fig. 4 a further confirmation of Horton's results is obtained, and further support to the suggestion that the 30.4 volt critical point of Fig. 3 is due to impurity and not to a true ionisation of helium. Point B (Fig. 4) ($V = 15.2$) can only be accounted for by direct ionisation since it is below the first resonance potential of helium, which causes the bend C. Hence it is concluded that point B is due to the presence of either carbon monoxide or water vapour or both. Points C and D are due respectively to the resonance and ionising potentials of helium. Points E and F can be explained by Bohr's theory which predicts double ionisation of helium at 82.9 volts (point F), and hence the loss of the second electron at $(82.9 - 25.6)$ volts from the previously ionised helium atom. Using the data of these experiments this effect should be apparent at $(80.5 - 25.1)$ volts or 55.4 volts, and was actually detected at 54.5 volts. No effects were apparent at any other points on the characteristic.

Referring to the mercury valve curves of Fig. 5, the bend B gives the true ionisation potential of mercury whilst point D is probably due to the presence of CO, as has already been indicated in reference to helium.

Should the resonance potential of the impurity be greater than 10.4 volts, in the case of a mercury valve, a further bend (type C) would be expected with a value between 10.4 and 15 volts. This effect is seen in the appearance of such a bend in Curve VI. of Fig. 6 where the resonance potential of argon (12.5, Table IV.), has caused an additional increase by ionising the mercury vapour.

From the foregoing discussion the argon curves are easily explained. The point B moves to the left as the mercury pressure is increased, thus

* *Philosophical Magazine*, 39, p. 597, 1919 (Fig. 3).

showing the true ionisation potential to be 16.5 (Curve I.), and from Curve VI. the true resonance potential is 12.5.

It was not found possible to continue these curves as in the case of helium owing to the breaking of the filament which occurred with the higher plate potentials. It is hoped to continue these experiments using a valve with a thicker filament.

The curves of Fig. 7 show that similar effects may be produced on a smaller scale by an increase in the pressure of pure gases.

7. Applications.

The circuit shown in Fig. 8 was used to test the rectifying properties of the various bends. The rectification, if any, above point C could not be detected owing to the valve noises which completely drowned any signal which might have been received.

At the bend C the rectification was found to be appreciable as long as the plate potential was just less than the ionising potential of the gas. A slight

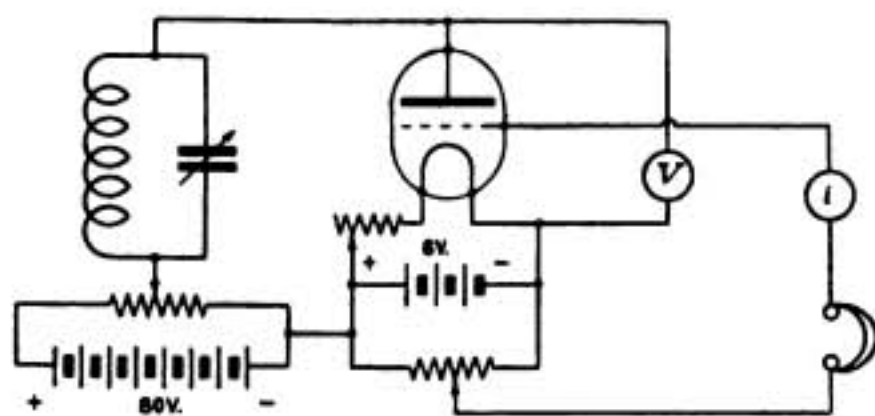

FIG. 8.

increase in V would immediately produce noises which effectively interfered with reception.

The intensity of the note when compared with that produced by the usual rectifying circuit was found to be in the approximate ratio of 0.6 : 1.0.

The decreasing slopes of the characteristic suggest the use of the valve as a negative resistance tube similar to the dynatron in which case the reversal of current is due to the secondary emission of electrons from the positive electrode. This method of employment is now being investigated.

8. Conclusions.

From the foregoing experiments it is concluded that :—

(1) The (i, V) and the (I, V) characteristics of a soft three-electrode valve can be utilised to determine the resonance and ionising potentials of the contained gas.

(2) The nature of the gas and the presence of impurities can be determined from the various critical points in these characteristics.

(3) Certain methods of measuring ionisation potentials are liable to error if impurities are present.

(4) The work of Professor Horton and Miss Bailey in which a trace of

mercury vapour was found to cause ionisation phenomena in helium at potentials ranging from the true ionisation potential to the resonance potential has been confirmed.

(5) This result has been extended to argon, in which gas traces of mercury vapour were found to cause similar effects.

(6) The observed value of the ionisation potential in a pure gas decreases slightly with increase of gas pressure causing changes in the characteristics similar to those produced by the addition of impurities.

(7) The following are the critical potentials obtained for helium and argon:—

Gas.	Resonance potentials (volts).	Ionising potentials (volts).
Helium . . .	20.7	25.5 (removal of 1st electron).
	45.8	54.5 (removal of 2nd electron).
	(41 ?)	80.5 (removal of both electrons).
Argon . . .	12.5	16.5 .

The above experiments were carried out in the Physics Department of the University of Bristol, and my best thanks are due to Professor A. M. Tyndall for his interest and advice during the work and for the facilities placed at my disposal.

The expenses entailed in this research were met by a grant from the University of Bristol Colston Research Fund.

The Physics Department,
The University, Bristol.

The Paris Radio Central.*

On January 9th, 1921, the foundation stone of the new Paris Radio Centre was laid in the grounds of the Château of Sainte-Assise, near Paris. The ceremony was performed by M. Louis Dechamps, the Under Secretary of State for the French Postal Telegraph Administration. A large number of official representatives were present amongst whom may be specially mentioned—General Ferrié, the Inspector-General of French Military Telegraphs, Captain Lagorio, the Director of the wireless branch of the Postal Telegraph Administration, M. Girardeau of the Cie. Générale de Télégraphie sans fil, and M. Brenot, Technical Director of the Société Française Radioélectrique.

The construction and working of this Radio Centre is being undertaken by the Compagnie Générale de Télégraphie sans fil, and its completion will give to France an incontestable superiority in the field of radio communications, and will enable the insufficiency of the cable communications to the French colonies and to other oversea countries to be overcome.

* Abstracted from information contained in the articles referred to in Abstracts Nos. 1542—1545 (see p. 156 in this issue).

The Paris Radio Central will comprise the following:—

An intercontinental transmitting station capable of an aerial output of from 200 to 1,500 kW according to the range to be covered.

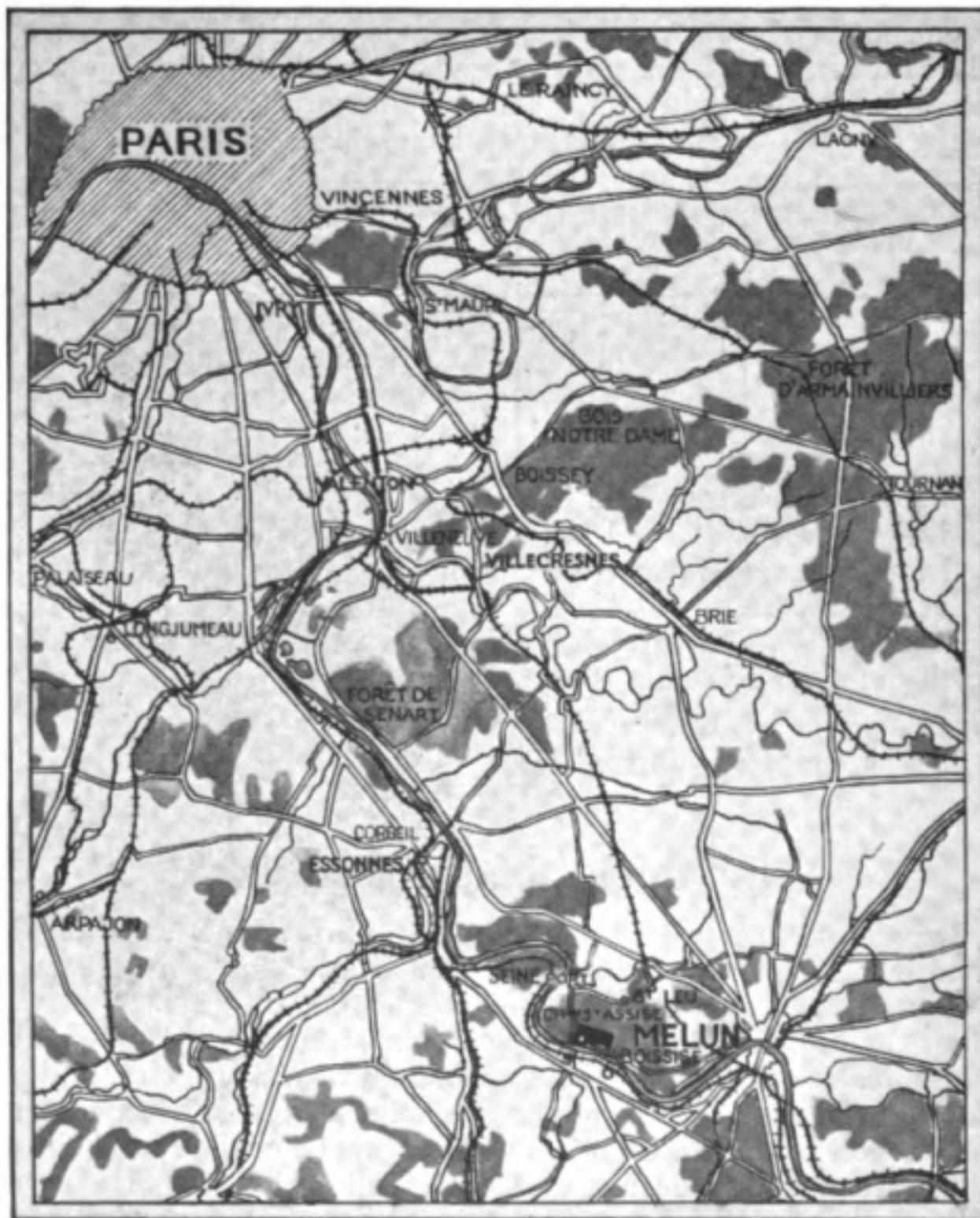

FIG. 1.—Map showing the location of the Transmitting Stations at Sainte-Assise, and the proposed sites for the Receiving Centres.

A Continental transmitting station capable of an output of 1 to 100 kW in the aerial, according to the distance to be covered.

One, and later two, receiving centres, each having seven groups of receiving apparatus.

A Central Bureau which may be likened to the nerve centre of the whole organisation.

Site of the Stations.

The two transmitting stations will be adjacent to one another for convenience in erection and control, but will be entirely distinct in buildings, machines, etc. The choice of a suitable site to comply with all the conditions laid down by the Postal Telegraph Department was not easy, and the one finally adopted was on the plateau of Sainte-Assise, twenty-five miles from Paris (Fig. 1). The site is bounded on the north by the road from Seine-Port to Saint-Leu, on the south and west by the Seine, and on the east by the railway from Melun to Brunoy. The site is approximately level, and a few metres below the surface sufficient ground water is present to ensure an adequate earth connection.

The "Intercontinental" Transmitting Station.

The station for intercontinental communication will be controlled from the Central Bureau at Paris, and will ensure regular and rapid communication

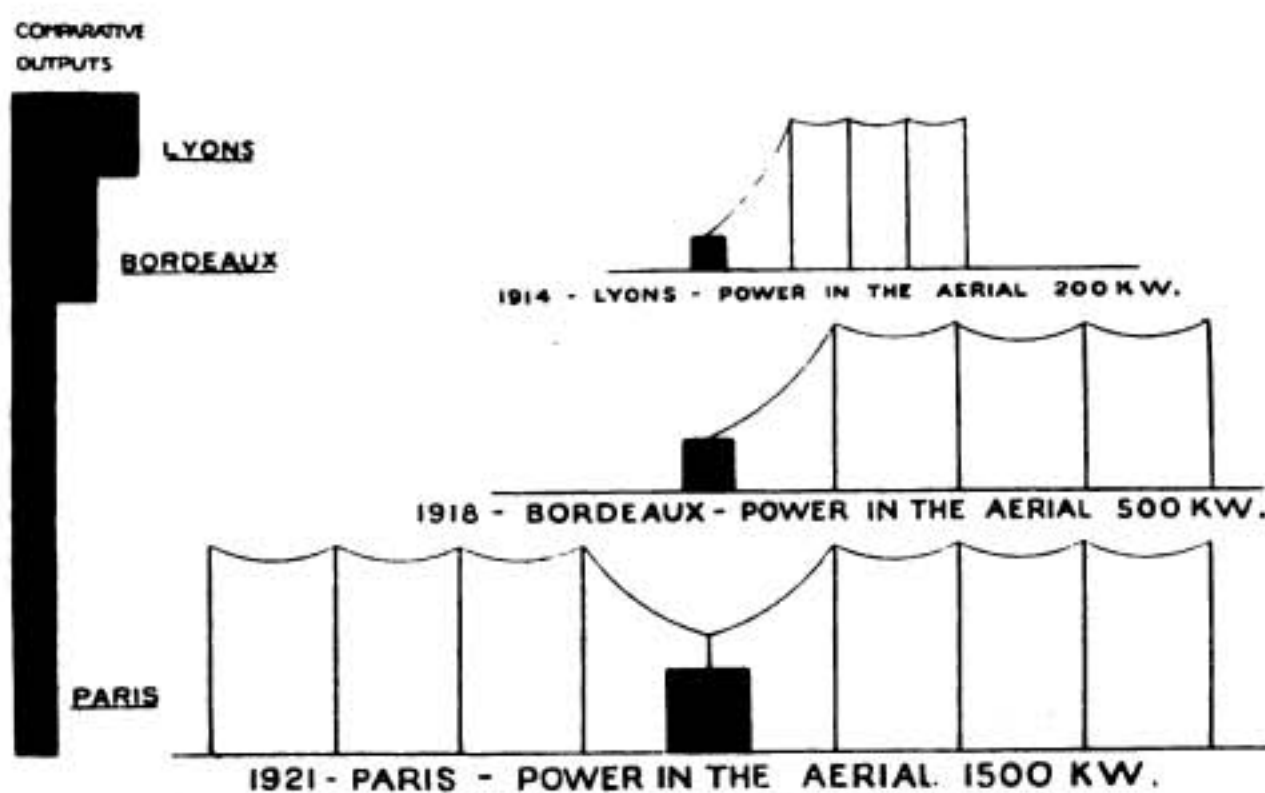

FIG. 2.—Comparative sizes of recent French Radio Stations.

with North, Central and South America, with Asia, and with South Africa. It will contain three high-frequency alternators each capable of delivering an output of 500 kW to the aerial. Each machine will be driven by a 450 kW, D.C. motor. These alternators can be used either separately or in conjunction, or can be grouped for two simultaneous transmissions, each of 250—500 kW antenna output, while eventually it is intended to provide for coupling the three machines to a single antenna to give an output of 1,500 kW (Fig. 2). The complete installation will comprise the antenna couplings, the control and regulating desks, the antenna loading inductances, the switchboards and auxiliary machines. Transmission will be possible at a speed of more than 100 words per minute at full power, so that with two

simultaneous transmissions the total output will exceed 12,000 words per hour.

Two sources of power supply will be available—from a power distribution network, and from an emergency installation of three Diesel engines, each of 1,800 H.P.

The aerial, of roughly twice the size of that at Bordeaux * will be supported by sixteen towers, 250 metres (830 feet) high, and will form a symmetrical double network covering an area of about 910,000 square metres (1·088 million square yards). About forty-three miles of aerial cable will be used in its construction, together with nearly ten miles of steel supporting cable.

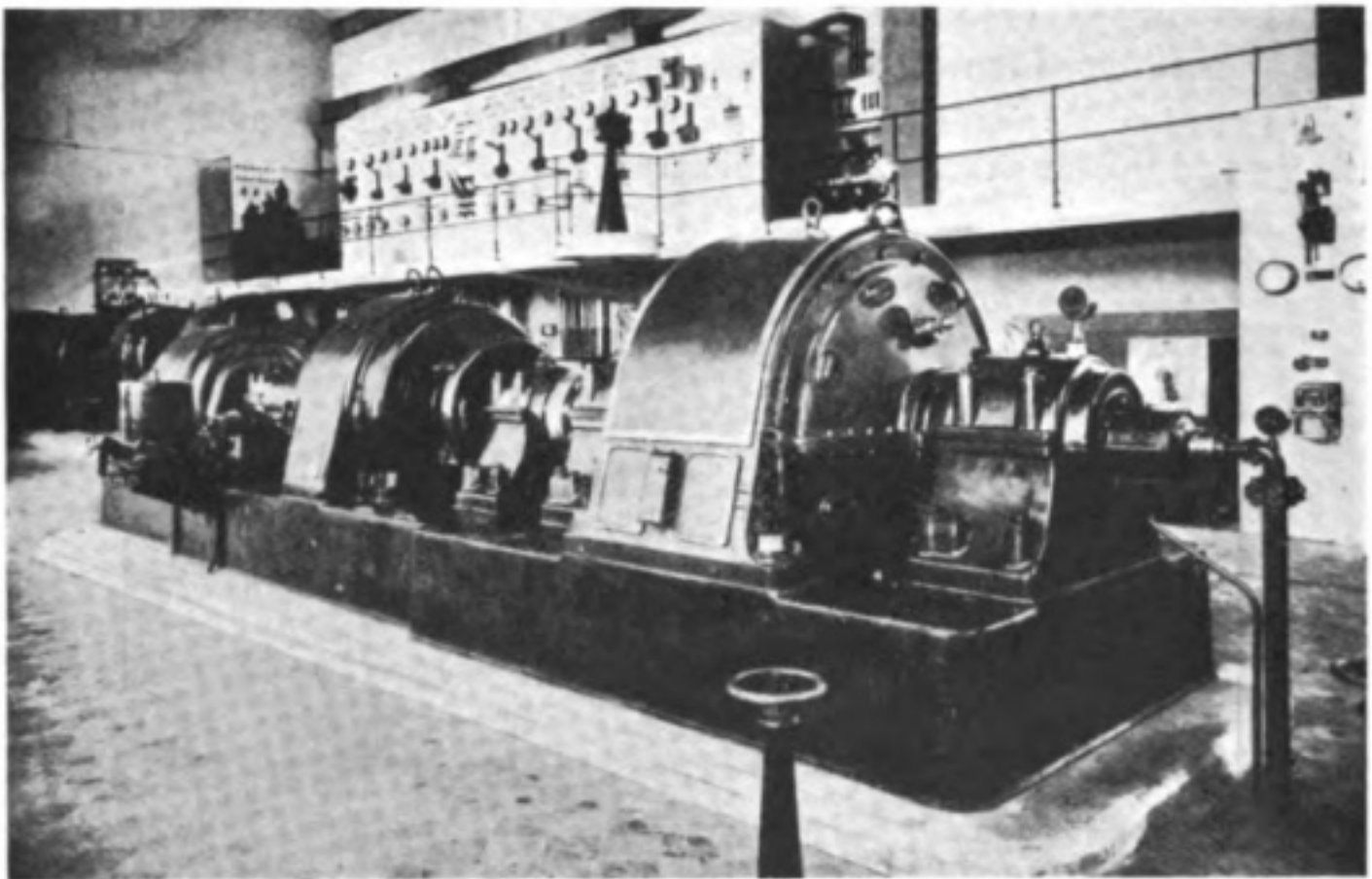

FIG. 3.—A high-frequency Alternator (200 kW output) of the type to be used in the Paris Radio Central Station.

The two halves of the aerial may be used separately for two simultaneous transmissions of reduced power, or they may both be grouped together for full power work. The earth system will be connected at numerous points with the ground water, and will consist of 800 square metres (950 square yards) of copper plates near the centre of the station building, together with 80,000 metres (forty-nine miles) of copper wire buried under the aerials, and covering a surface of over two million square yards in area.

The station building will be divided into three parts—containing respectively (1) the high-frequency machines and their accessories; (2) the power units (Diesel engines and generators), the workshops and stores; and (3) the offices, etc.

* See p. 87 of our last issue.

The "Continental" Transmitting Station.

Situated in the immediate neighbourhood of the intercontinental station, this one will serve for regular radio traffic within a radius of 3,000 km from Paris. It also will be controlled directly from the Central Bureau in Paris. It will contain two complete transmitting units each comprising two high-frequency alternators with an output of 25 aerial kW each. They can be arranged either for a single transmission with a power of from 12 to 100 kW in the aerial, or for two simultaneous transmissions of 12 to 50 kW each.

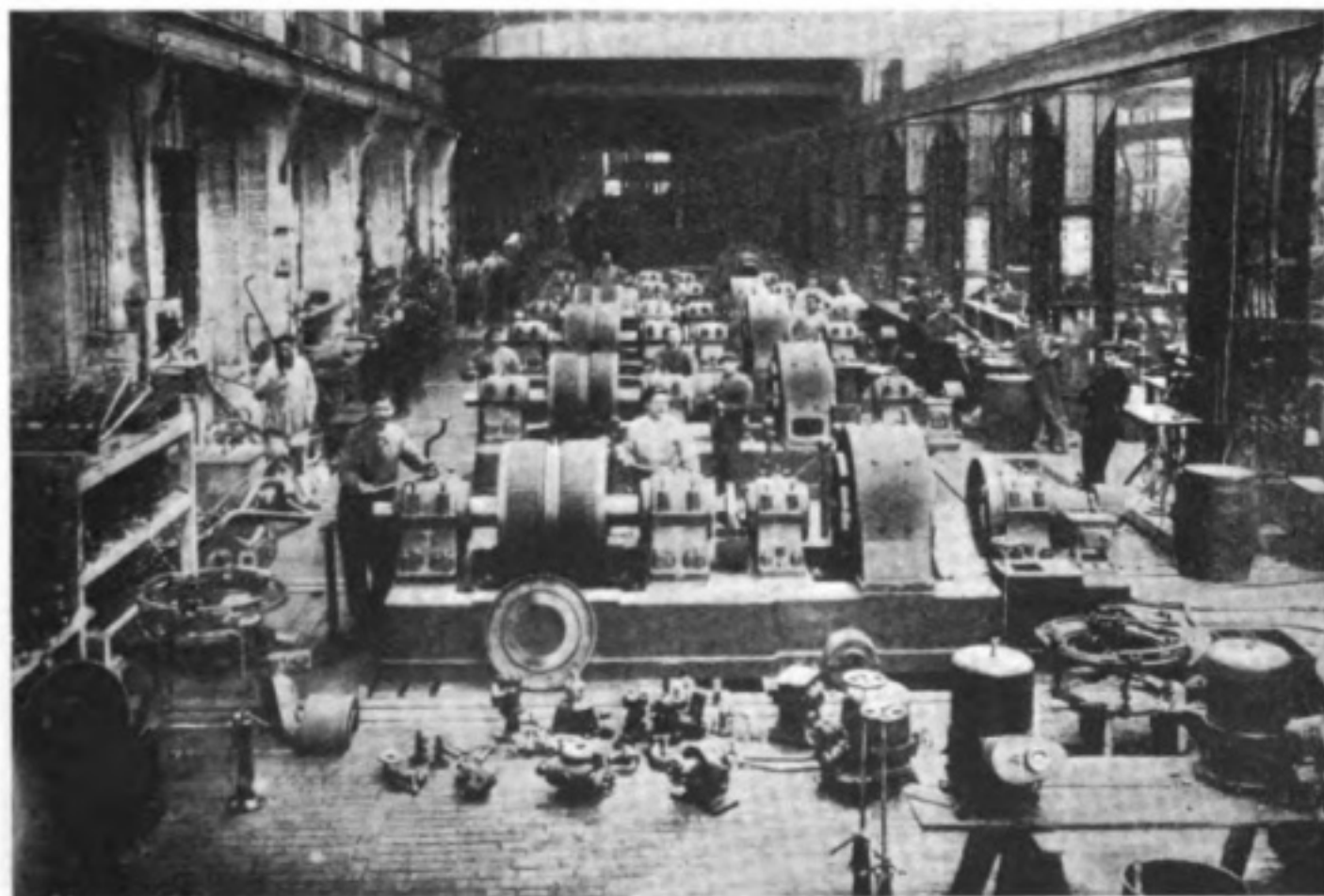

FIG. 4.—A group of large High-frequency Alternators under construction in the Works of the Société Alsacienne de Constructions Mécaniques at Belfort.

Transmission may be effected with a speed of over 100 words per minute at full power.

As in the case of the larger station, an auxiliary power supply will be provided in the form of two Diesel engine generators of 160 H.P. each.

The aerial of the "double cone" type will have four independent networks and will be supported by a single guy-supported tower 250 metres (830 feet) in height, and by thirty-six auxiliary poles 10 metres high. It will contain thirteen miles of aerial cable and nine miles of steel supporting cable. The earth system will consist of 200 square metres (240 square yards) of copper plates and ten miles of buried copper wires.

The buildings of the Château of Sainte-Assise already in existence will be utilised eventually for auxiliary radio services and transmitting installations for new communication routes.

The Receiving Centres.

The sites for these stations that have been tentatively decided upon are at Villecresnes, 22 kms S.S.E. of Paris, at Essonnes, 30 kms south of Paris, and Valenton, 18 kms S.S.E. of Paris. (See Figs. 1 and 5.)

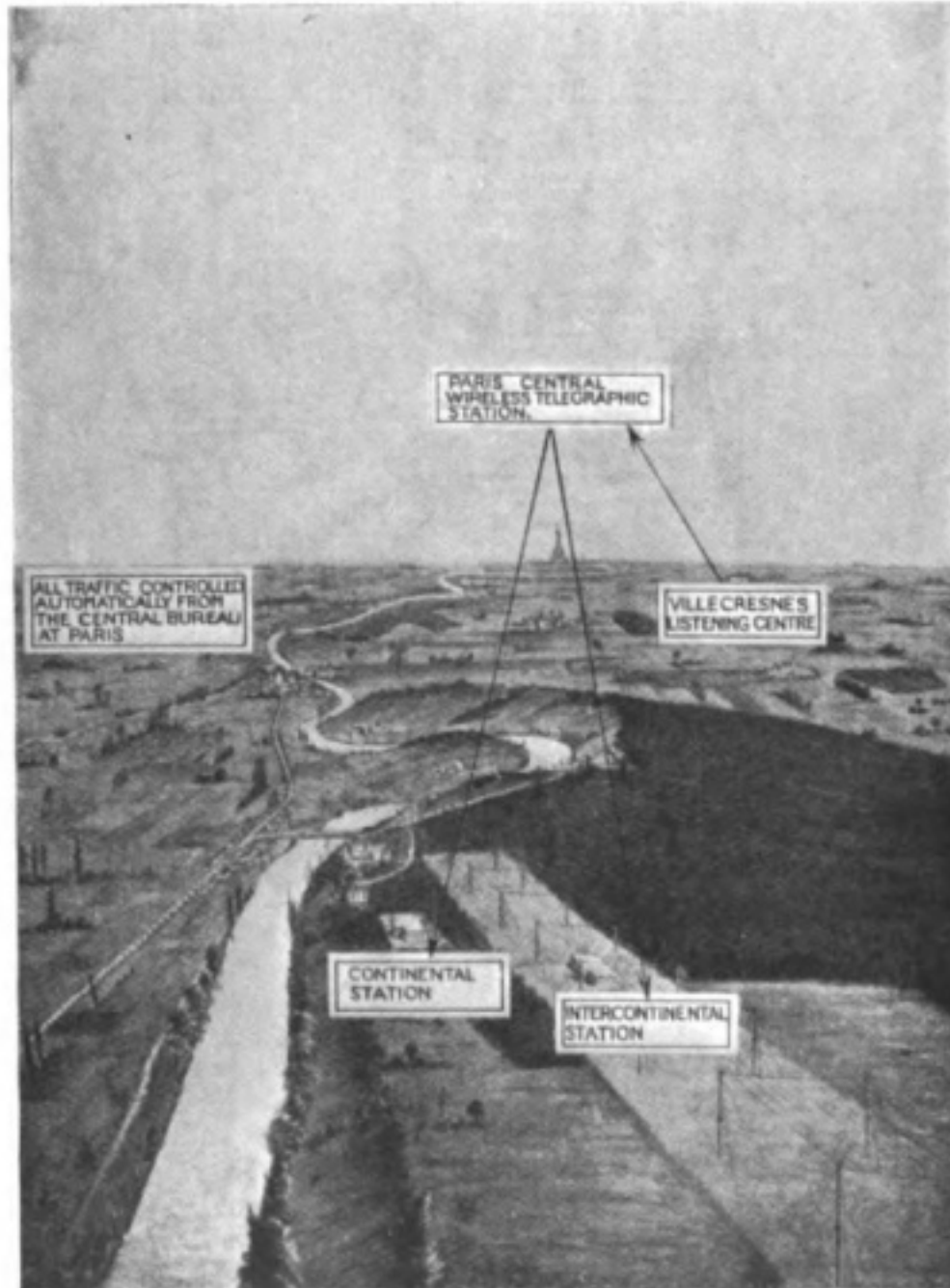

(Radiodirectricité.)

FIG. 5.—The Paris Radio Central Station.

The first reception centre will in its initial stages contain three receiving stations for communications with North and South America, and with Asia, two stations for European traffic, and one for training purposes. Each receiving station will contain, (1) a double set of selective receiving apparatus with a frame aerial; high and low-frequency amplifiers, heterodynes, anti-atmospheric devices, together with the necessary batteries and valves, all enclosed in a screened cabin; and (2) automatic photographic or phonographic recording apparatus for high-speed working (Figs. 6 and 7).

The whole apparatus will be made sufficiently sensitive and selective to

carry on duplex working with the American stations, without the use of any antenna or frame aerial external to the receiving apparatus. The receiving

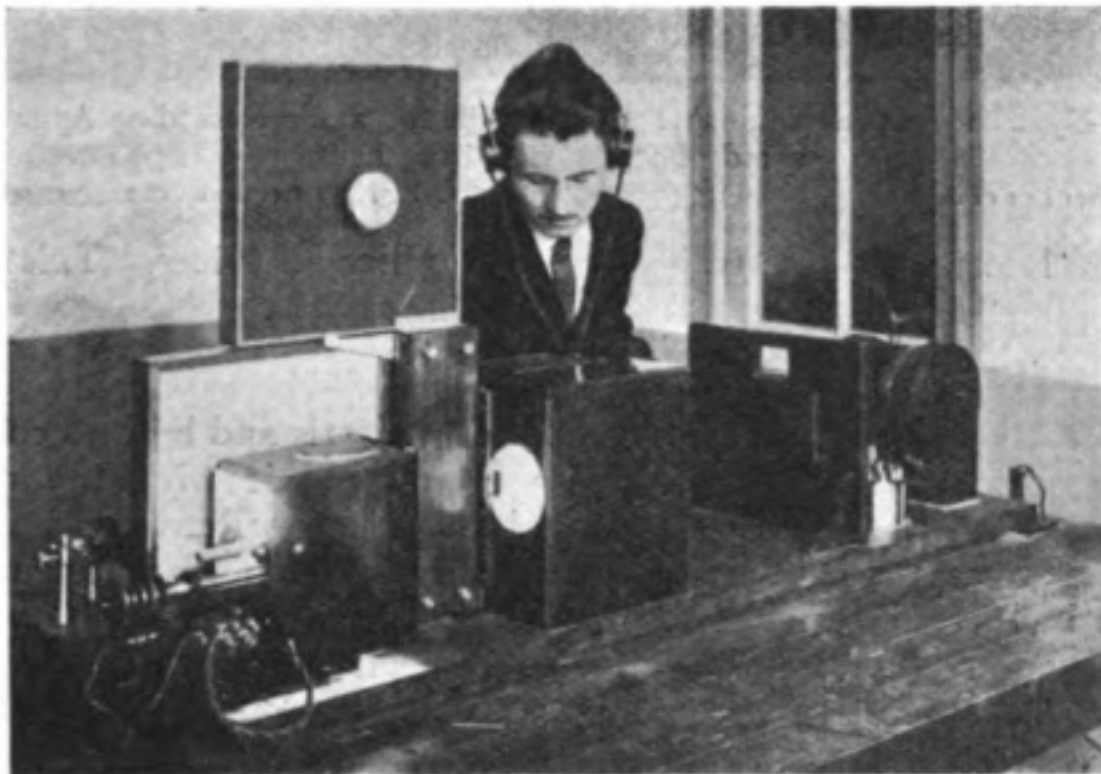

FIG. 6.—Photographic Recording Apparatus.

centre will be connected by direct telephone lines with the Central Bureau, and the incoming telegrams will be sent on to the Bureau by means of two



FIG. 7.—Phonographic Recording Apparatus.

sets of quadruplex Baudot apparatus. Each receiving centre will consist of six to eight single story buildings containing the frame aerials, the anti-atmospheric and receiving apparatus, and one central building devoted to the reception and recording of the messages picked up by the frame aerials,

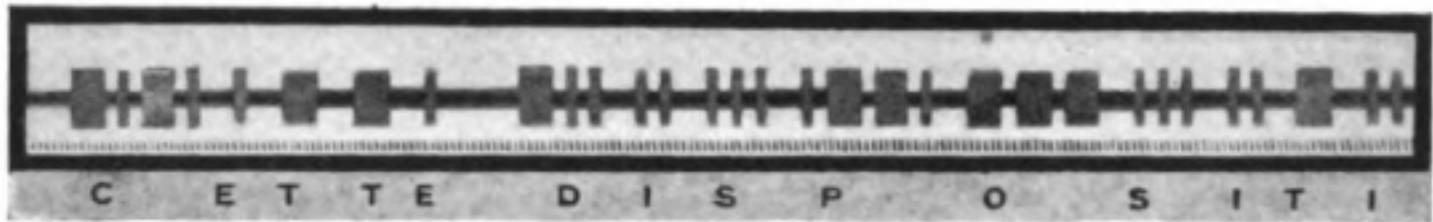

FIG. 8.—Type of Record obtainable with the Photographic Recording Apparatus at a speed of 12,000 words per hour.

The lower line of dots shows the vibrations of a tuning-fork having a frequency of 200 per second.

to the land line telegraphic traffic and to auxiliary services. This building will be about 220 yards distant from the frame aerials.

The Central Bureau.

This bureau will be located near the heart of Paris and besides containing the quadruplex telegraphic apparatus connecting it with the receiving stations and with the other land line telegraphic distribution services, will contain the apparatus for the distant control of all the distant transmitting apparatus included in the scheme. It is estimated that when working at full capacity this system will be capable of dealing with about two million words per twenty-four hour day.

Some samples of the type of record obtainable with the photographic recording apparatus proposed for use in the receiving stations are given in Fig. 8. The anti-atmospheric arrangements to be employed are based on the utilisation of a series of coupled and tuned filtering circuits forming a

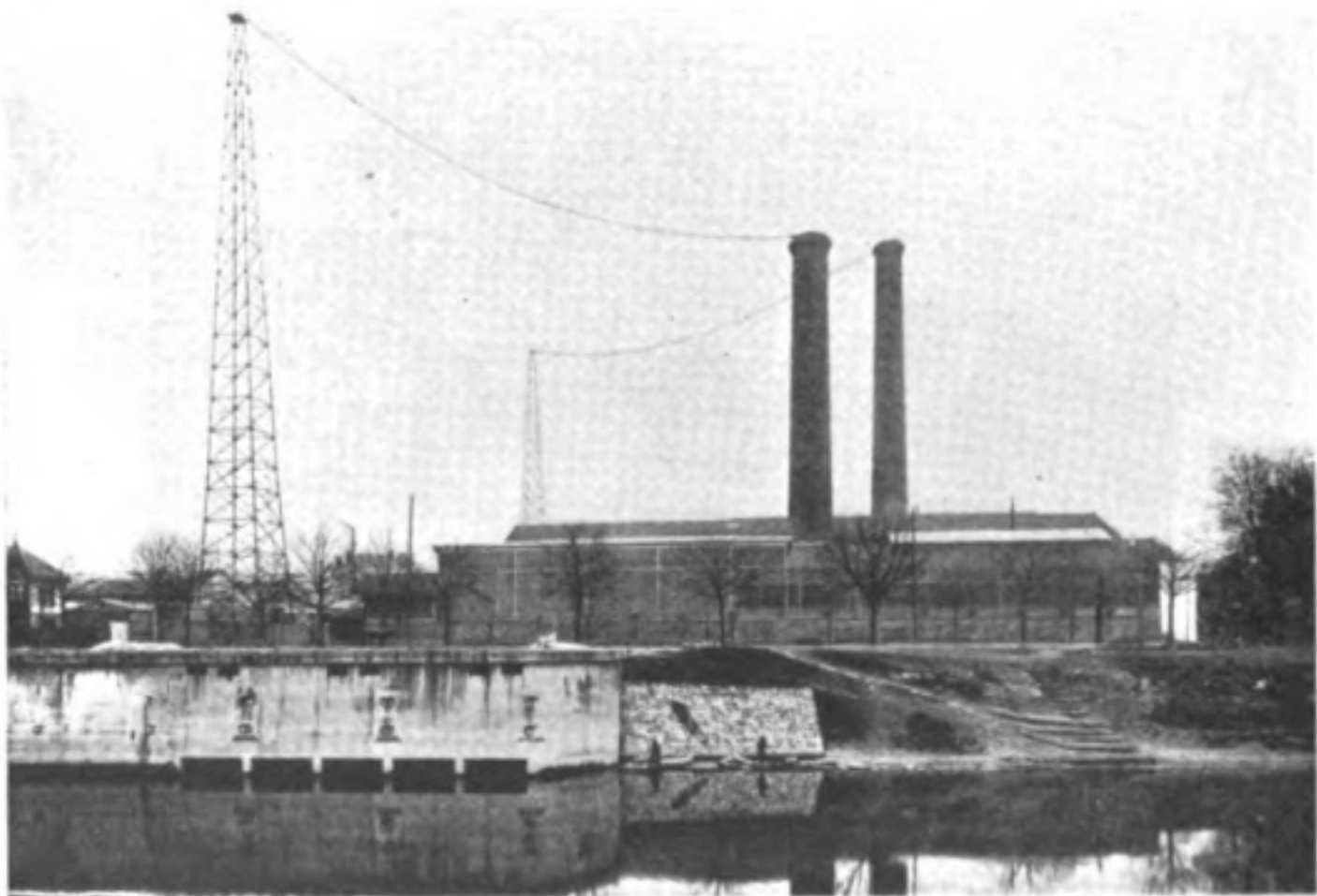

FIG. 9.—The Paris Terminal of the London-Paris Service at the Levallois Works of the Société Française Radioélectrique.

species of "artificial line." This arrangement also gives great selectivity and enables a receiving station to be operated quite close to a transmitter provided that there is not less than 2 per cent. difference between the wavelengths of the two stations.

The London-Paris Service.

While awaiting the completion of the larger schemes outlined above, the Compagnie Générale de Télégraphie sans fil has announced its intention of inaugurating certain preliminary communication routes where the traffic is the heaviest. The first of these to be put into service was that between London and Paris which was opened during January.* The London end of the service is a station near Chelmsford operated by Marconi's Wireless Telegraph Co., while at the Paris terminal a station at the Levallois works of the Société Française Radioélectrique has been employed (Fig. 9).

A temporary Central Bureau has been opened in Paris at 79 Boulevard Haussmann. The actual radio transmission is controlled by a perforated tape of the Wheatstone type, a valve transmitter, delivering 2.5 kW in the aerial, being employed. The towers at the transmitting station illustrated in Fig. 9, are 225 feet high. Reception is effected on a frame aerial in the Central Bureau. Phonographic reception of the messages is adopted, the records being subsequently run over at a lower speed and transcribed by ear.

**A Note on the Theory of the
Thermionic Tube.**

By J. A. FLEMING, M.A., D.Sc., F.R.S.

In the *Physical Review* for 1913 (vol. 2, p. 453) and also in the *Proceedings of the Institute of Radio Engineers* for September, 1915 (vol. 3, p. 269) Mr. Irving Langmuir has given equations for the thermionic current i between a hot and cold cathode and anode in terms of their potential difference V and proved that i varies as $V^{3/2}$. This proof depends upon certain assumptions which are not justifiable, but my object here is not to criticise these postulates but to give a proof of the equation for one particular case and point out a small error (as I think) in the solution as given by Mr. Langmuir in the *Physical Review*.

The case considered is that of a hot wire, the radius of cross section of which is a , placed in the axis of a cylindrical anode, the radius of which is R , kept at a potential V_0 .

Let V be the potential at a point at distance r from the centre of the wire.

Assuming then that ρ is the density of the space charge at that point and v the velocity of the electrons the thermionic current per unit length of the cathode is,

$$i = - 2\pi r \rho v \dots \dots \dots (1)$$

If we assume that the electrons are emitted from the cathode without

* See p. 99 in our last issue, Note No. 1914.

initial velocity, which is certainly not the case, and if we *assume* that the cathode is all at zero potential, which is not true, then we can say that,

$$eV = \frac{1}{2}mv^2 \dots \dots \dots (2)$$

where e and m are the charge and mass of the electron.

Hence
$$v = \sqrt{\frac{2e}{m}} \cdot \sqrt{V} \dots \dots \dots (3)$$

Now at the point r the potential and density are connected by Poisson's equation which in polar form adapted to this case is

$$\frac{d^2V}{dr^2} + \frac{1}{r} \frac{dV}{dr} = -4\pi\rho \dots \dots \dots (4)$$

Substituting from equations (1) and (3) we have

$$rV^{\frac{1}{2}} \left(\frac{d^2V}{dr^2} + \frac{1}{r} \frac{dV}{dr} \right) = 2i \sqrt{\frac{m}{2e}} \dots \dots \dots (5)$$

or
$$r \frac{d^2V}{dr^2} + \frac{dV}{dr} = \frac{A}{\sqrt{V}} \dots \dots \dots (6)$$

where $A = 2i \sqrt{\frac{m}{2e}}$.

The problem then is, to solve (6). At first sight it looks as if it might be a form of Bessel's equation but I have not been able to reduce it to any typical form of Bessel's equation.

A solution applicable in the present case may be found as follows:—

Assume that a solution of (6) can be found in the form

$$V = r^n \phi(r) \dots \dots \dots (7)$$

Where $\phi(r)$ is some function of r of the form $\phi(r) = \beta^m K$ and K is some constant.

We have to find the conditions under which $V = r^n \beta^m K$ can be a solution of (6).

We have then,

$$\begin{aligned} \frac{dV}{dr} &= \left(nr^{n-1}\beta^m + r^n m \beta^{m-1} \frac{d\beta}{dr} \right) K \\ r \frac{d^2V}{dr^2} &= \left(n n - 1 r^{n-1} \beta^m + nr^n m \beta^{m-1} \frac{d\beta}{dr} + nr^n m \beta^{m-1} \frac{d\beta}{dr} + \right. \\ &\quad \left. + r^{n+1} m \overline{m-1} \beta^{m-2} \left(\frac{d\beta}{dr} \right)^2 + r^{n+1} m \beta^{m-1} \frac{d^2\beta}{dr^2} \right) K \end{aligned}$$

and
$$\frac{A}{\sqrt{V}} = Ar^{-\frac{n}{2}} \beta^{-\frac{m}{2}} K^{-\frac{1}{2}} \dots \dots \dots (8)$$

Hence in order that r^n may be a factor in the solution $d\beta/dr$ must contain a factor $1/r$ and $d^2\beta/dr^2$ must contain a factor $1/r^2$. Also β must be zero when $r = a$.

A function which fulfils this condition is

$$\beta = \log \frac{r}{a} + a_2 \left(\log \frac{r}{a} \right)^2 + a_3 \left(\log \frac{r}{a} \right)^3 + \text{etc.} \quad \dots \quad (9)$$

Hence if we differentiate (9) and write $f(r)$ for $rd\beta/dr$ and $F(r)$ for $r^2d^2\beta/dr^2$ and substitute these values in (8) we have

$$Kr^{n-1} \{ n^2\beta^m + (m + 2nm) \beta^{m-1} f(r) + m \overline{m-1} \beta^{m-2} [f(r)]^2 + m\beta^{m-1} F(r) \} = Ar^{-\frac{n}{2}} \beta^{-\frac{m}{2}} K^{-\frac{1}{2}} \dots \quad (10)$$

In order that r^n may be a factor in the solution we must have $\overline{n-1} = -\frac{n}{2}$ or $n = 2/3$. Substituting this in (10) we have

$$K\beta^{m-2} \left\{ \frac{4}{9} \beta^2 + \frac{7}{3} m\beta f(r) + m \overline{m-1} [f(r)]^2 + m\beta F(r) \right\} = A\beta^{-\frac{m}{2}} K^{-\frac{1}{2}} \quad (11)$$

Hence in order that β^m may be a factor in the solution we must have $m - 2 = -m/2$ or $m = 4/3$ and also the contents of the large bracket in (11) must be unity.

Hence we have

$$\frac{4}{9} K \{ \beta^2 + 7\beta f(r) + 3\beta F(r) + [f(r)]^2 \} = AK^{-\frac{1}{2}} \dots \quad (12)$$

We have finally to find the conditions that the contents of the large bracket in (12) may be unity.

Let $x = \log \frac{r}{a}$, then we have,

$$\beta = x + a_2x^2 + a_3x^3 + a_4x^4 + \text{etc.} \quad \dots \quad (13)$$

$$\beta^2 = x^2 + 2a_2x^3 + (2a_3 + a_2^2)x^4 + (2a_4 + 2a_2a_3)x^5 + \text{etc.} \quad \dots \quad (14)$$

$$f(r) = 1 + 2a_2x + 3a_3x^2 + 4a_4x^3 + \text{etc.} \quad \dots \quad (15)$$

$$F(r) = (2a_2 + 1) + (6a_3 - 2a_2)x + (12a_4 - 3a_2^2)x^2 + \text{etc.} \quad \dots \quad (16)$$

Substituting these values in (12) we obtain

$$\begin{aligned} \frac{4}{9} K \left\{ 1 + (10a_2 + 4)x + (24a_3 + 12a_2 + 10a_2^2 + 1)x^2 + \right. \\ \left. + (44a_4 + 16a_3 + 36a_2a_3 + 8a_2^2 + 2a_2)x^3 + \text{etc.} \right\} \\ = AK^{-\frac{1}{2}} \dots \quad (17) \end{aligned}$$

Hence in order that β^m may be a factor in the solution the coefficients of all the powers of x in the bracket in (17) must be zero, or,

$$10a_2 + 4 = 0 \quad \therefore a_2 = -\frac{2}{5}$$

$$24a_3 + 12a_2 + 10a_2^2 + 1 = 0 \quad \therefore a_3 = \frac{11}{120}$$

$$44a_4 + 16a_3 + 36a_2a_3 + 18a_2^2 + 2a_2 = 0 \quad \therefore a_4 = -\frac{47}{3300}$$

$$\text{and also } \frac{4}{9}K = AK^{-1} \quad \therefore K = \left(\frac{9}{4}A\right)^{\frac{2}{3}}$$

Accordingly $V = \left(r\beta^2 \frac{9}{4}A\right)^{\frac{2}{3}}$ is a solution of (6) and we have

$$i = \frac{2}{9}\sqrt{\frac{2e}{m}} \frac{V^{\frac{3}{2}}}{r\beta^2} \dots \dots \dots (18)$$

where

$$\beta = \log \frac{r}{a} - \frac{2}{5}\left(\log \frac{r}{a}\right)^2 + \frac{11}{120}\left(\log \frac{r}{a}\right)^3 - \frac{47}{3300}\left(\log \frac{r}{a}\right)^4 + \text{etc.} \dots (19)$$

This agrees with Langmuir's solution (although he gave no detailed proof) with the difference that in his equation for β the coefficient of the second term is given as $\frac{2}{3}$ instead of $\frac{2}{5}$.

Since Langmuir's solution has been reproduced by other writers without proof and without correction of the above slip (as I think) it seemed worth while to put on record what I believe is the correct solution of the equation (6) above given.

Editorial Note.

With reference to the above paper, the discrepancy pointed out by Professor Fleming between his result and that obtained by Langmuir is merely due to a printer's error in Langmuir's paper in the *Physical Review*, where in equation (18) the coefficient of γ^2 is given as $\frac{2}{3}$ instead of $\frac{2}{5}$. The coefficient of γ^3 which involves that of γ^2 is correctly given, and by checking any one of the numerical values in Langmuir's Table I., it is seen at once that they are correctly calculated, *i.e.*, with $\frac{2}{5}\gamma^2$ and not with $\frac{2}{3}\gamma^2$. Professor Fleming has done a useful service, however, in pointing out the error in the equation as printed and in giving another method of solving the equation. As Professor Fleming mentions, Langmuir does not give the details of his solution, but it is a relatively simple matter and as it deals with a subject of some importance we have worked it out and give it here, so that readers can compare it with Professor Fleming's method.

a is the radius of the filament, V the potential at any radius r , i the current, e and m the charge and mass respectively of the electron. Then the equation to be solved is:—

$$r \frac{d^2V}{dr^2} + \frac{dV}{dr} = i\sqrt{\frac{m}{e}} \frac{2}{V} \dots \dots \dots (1)$$

Putting the solution in the form $i = \frac{2\sqrt{2}}{9} \sqrt{\frac{e}{m}} \cdot \frac{V^{\frac{3}{2}}}{r\beta^2} \dots \dots \dots (2)$

we have to determine β . Substituting for i in the first equation it becomes

$$r \frac{d^2V}{dr^2} + \frac{dV}{dr} = \frac{4}{9} \frac{V}{r\beta^2} \dots \dots \dots (3)$$

where from (2) $V = \left(\frac{i}{\frac{2\sqrt{2}}{9} \sqrt{\frac{e}{m}}} \right)^{\frac{2}{3}} r^{\frac{2}{3}} \beta^{\frac{4}{3}} = kr^{\frac{2}{3}} \beta^{\frac{4}{3}} \dots \dots \dots (4)$

where k is a constant for a given current i .

If from (4) we find $\frac{dV}{dr}$ and $\frac{d^2V}{dr^2}$ and substitute in (3) we obtain

$$3\beta r^2 \frac{d^2\beta}{dr^2} + r^2 \left(\frac{d\beta}{dr} \right)^2 + 7\beta r \frac{d\beta}{dr} + \beta^2 - 1 = 0 \dots \dots (5)$$

Now putting $r = a\epsilon^\gamma$, $\frac{d\beta}{dr} = \frac{1}{r} \frac{d\beta}{d\gamma}$ and $\frac{d^2\beta}{dr^2} = \frac{1}{r^2} \left(\frac{d^2\beta}{d\gamma^2} - \frac{d\beta}{d\gamma} \right)$

equation (5) becomes

$$3\beta \frac{d^2\beta}{d\gamma^2} + \left(\frac{d\beta}{d\gamma} \right)^2 + 4\beta \frac{d\beta}{d\gamma} + \beta^2 - 1 = 0 \dots \dots (6)$$

To find β in terms of γ , we assume the power series

$$\beta = \gamma + A\gamma^2 + B\gamma^3 + C\gamma^4 + D\gamma^5 + E\gamma^6 + \dots$$

then $\frac{d\beta}{d\gamma} = 1 + 2A\gamma + 3B\gamma^2 + 4C\gamma^3 + 5D\gamma^4 + 6E\gamma^5 + \dots$

Similarly $\frac{d^2\beta}{d\gamma^2}$, $\left(\frac{d\beta}{d\gamma} \right)^2$ etc., can be found and substituted in equation (6).

Since this equation must hold for all values of γ , the coefficients of the various powers of γ must each be equal to zero. The equation becomes

$$(10A + 4)\gamma + (10A^2 + 12A + 24B + 1)\gamma^2 + \dots = 0$$

hence $10A + 4 = 0$ and $A = -\frac{2}{5}$.

Similarly $B = \frac{11}{120}$ and $C = -\frac{47}{3300}$

and $\beta = \gamma - \frac{2}{5}\gamma^2 + \frac{11}{120}\gamma^3 - \frac{47}{3300}\gamma^4 + \dots$

This is the value of β which, inserted in equation (2), gives the current through the thermionic tube. As Langmuir points out, however, in most practical cases β approximates very closely to unity.

Measurements of Radiation of Radiotelegraphic Aerials.

By G. VALLAURI.

(Continued from page 85.)

7. Measurement of the Resistance of the Receiving Circuit.—Having obtained the value of I_r from the reading of the instruments and from the calibration constant, it is necessary to know the impedance of the receiving aerial to pass to the determination of the induced E.M.F. by means of (9). To determine the impedance the method chosen is to make the receiving aerial oscillate (either by the waves from the transmitter or by a local source of oscillations) with the same wavelength as is used in the measurements and to ascertain the variations of I_r through the effect of the insertion in the circuit of known supplementary impedances. The measurement is especially simple when the receiving circuit is in resonance, that is to say, when a variable condenser is inserted in it which is adjusted to obtain the maximum value of I_r . In this case, the reactance is null and the impedance is reduced to the mere total ohmic resistance. If then the receiving circuit is excited by a generator of persistent oscillations with a very loose coupling (as for example by the transmitting station itself), and a known resistance R' is inserted in series, the current is seen to diminish from the value I_r to the value I_r' and, as we may consider the induced E.M.F. to be constant, we get

$$R_r = R' \frac{I_r'}{I_r - I_r'} \dots \dots \dots (10)$$

If, on the contrary, the excitation is made by damped oscillations and always with a very loose coupling, and at resonance, it is necessary to know besides λ and the decrement δ of the exciting oscillation, also the self-induction L (or the capacity C) of the receiving circuit* because then in the relation †

$$\left(\frac{I_r}{I_r'}\right)^2 = \frac{\delta_r'(\delta_t + \delta_r')}{\delta_r(\delta_t + \delta_r)} \dots \dots \dots (11)$$

in which the decrements δ_r and δ_r' are equal to $\pi \sqrt{\frac{C}{L}} R_r$ and $\pi \sqrt{\frac{C}{L}} (R_r + R')$ respectively, R_r is the only unknown. Nor can there be any ambiguity in its determination although the relation is of the 2nd degree, since the equation gives only one positive physically acceptable solution.

* For this purpose it is sufficient to calibrate the variable tuning condenser, because then from the values of λ and C we get by the formula for resonance, $L = \frac{1}{4\pi^2 C} \left(\frac{\lambda}{u}\right)^2$.

† Deduced from the known expression for the current at resonance (see Zenneck-Seelig, *loc. cit.*, p. 105).

Finally the measurement of R_r can be made by the addition of R' and with damped oscillations in the receiving circuit, using the method of excitation known as impulsion. For example, it can be applied by inserting in another circuit acting on the receiving circuit through a magnetic coupling (that is, inductively) a vibrator (or buzzer) producing rhythmic and sudden interruptions of current. At the moment of the breaking of the primary current, a portion of the stored energy of the magnetic field is set free in the receiving circuit and gives rise to an oscillation. If the working of the buzzer is regular and the reaction of the secondary current on the primary is negligible, it may be assumed that the power transformed into oscillatory current in the receiving circuit in the two cases (resistance R_r and $R_r + R'$) is the same; we get therefore

$$R_r = R' \frac{I_r'^2}{I_r^2 - I_r'^2} \dots \dots \dots (12)$$

8. Calculation of the Effective Height.—Having measured I_r and deduced R_r by one of the experiments just stated, if the reception is made on an open aerial connected with the earth and equivalent to a half dipole h_r high, the effective height h of the sending antenna is found from equations (9a) (7) and (4), in which $\theta = \pi/2$ for the radiation at the earth's surface (or in the equatorial plane of the oscillator):

$$h = \frac{I_r}{I} \cdot \frac{dR_r \lambda}{4\pi\mu u h_r} \dots \dots \dots (13)$$

If, on the contrary, the reception is made on a closed aerial, we have from (9a) (8) and (4), always supposing $\theta = \pi/2$

$$h = \frac{I_r}{I} \frac{dR_r \lambda^2}{8\pi^2 \mu u S_r \cos \alpha} \dots \dots \dots (14)$$

Equations (13) and (14) as well as (9a) from which they have been deduced, refer to the case in which the transmission current I is undamped. On the other hand, in the case when I consists of a series of damped oscillations of decrement δ_t , if it is assumed that the electromagnetic field at any point and especially at the receiving station is subject to the same exponential damping law as the current I , equations (4) (7) and (8) can still be considered valid by referring them to the new effective values of I , F , H and E .^{*} For equation (9a) we substitute instead in this case the following (9b), in which appear the logarithmic decrements already defined for equation (11)

$$I_r = E \frac{\lambda}{2uL} \cdot \frac{1}{\sqrt{\delta_r(\delta_t + \delta_r)}} \dots \dots \dots (9b)$$

^{*} It is easily demonstrated that the effective value A of the magnitude composed of a series of damped oscillations of the type $a = A_0 e^{-at} \sin \omega t$ which succeed each other with frequency ν is expressed by $A = \frac{1}{2} \sqrt{\frac{\nu}{a}} A_0$ when the frequency of oscillation $f = \omega/2\pi$ is sufficiently great in comparison with the frequency of the discharges and the logarithmic decrement $\delta = a/f$ itself is sufficiently high to allow us to consider an oscillation as entirely exhausted, at the moment when the successive one begins.

Hence, together with (7) (8) and (4) :—

$$h = \frac{I_r}{I} \cdot \frac{dL\sqrt{\delta_r(\delta_t + \delta_r)}}{2\pi\mu h_r} \dots \dots \dots (13a)$$

$$h = \frac{I_r}{I} \cdot \frac{dL\lambda\sqrt{\delta_r(\delta_t + \delta_r)}}{4\pi^2\mu S_r \cos \alpha} \dots \dots \dots (14a)$$

The effective height h of the sending antenna being known and I and λ measured, the radiation resistance R_i and the power radiated P_i are easily calculated by means of equation (5).

9. Influence of the Distance, Position and Form of the Two Aerials.—

Up to the present it has been assumed that, in order to deduce the value of the height of radiation h from the measurements of the magnetic field H , the relations (4) were applicable. But in their turn these have been deduced on the hypothesis that the distance of the receiving aerial from the sending one was sufficiently great to render negligible the direct inductive action (of which no account is taken in equation (4)), and that therefore the Hertzian action alone, that is to say, the phenomenon of propagation by waves, existed. It is, however, easy to calculate that, with the ordinary dimensions of aerials, direct action is practically negligible at a distance equal to λ , and that therefore it is a more than sufficient precaution to place the receiving station at distances not less than about 2λ . With sufficiently sensitive instruments available, the receiving station can be arranged even at considerably greater distances without any effects of absorption being noticeable, except in the case of special inequalities of the intervening ground.

In this way also these inequalities of the ground can give rise within the limits of distances of some wavelengths, to deformations of the wavefront, which do not allow us to consider F as vertical and H as horizontal and both as perpendicular to the line joining the transmitting and receiving aerials.

In a similar way, with the ordinary magnitude of the horizontal dimension of the closed receiving frames in comparison with the wavelength, the error depending on the imperfect coincidence of phase of the magnetic flux through the various elements of the surface of the circuit, is quite negligible.

The relations (4) are moreover based on the assumption that the sending antenna is equivalent to a half dipole of such height h that with the same λ and I it gives rise to the same radiation. This definition is not ambiguous and allows the calculation of the power radiated by equation (5), if the sending antenna radiates equally in all directions and therefore if the simple assumption can be made with respect to $\sin \theta$ where θ is the angle between the direction of propagation and the axis of the dipole. Experience has demonstrated that this condition is approximately fulfilled in the case of modern aerials with a relatively concentrated capacity, that is to say, constituted by a horizontal portion (a bundle or network of wires in the form of a triangle) or square or even of a rectangle or trapezium of not too elongated a form, and leading down wires connected with the centre or with one of the sides or vertices of the horizontal part. In the case of the Marconi type of bent aerials, on the contrary, with a great horizontal development, or of other

types of directive aerials, the radiation does not take place equally in the various directions of the horizon, so that the measurements must be repeated in several sectors. To the results of each one of such measurements we can still apply equations (13) and (14), deducing the corresponding effective height h , but since the latter varies from one sector to the other, we cannot utilise (5) directly in order to deduce the radiation resistance and the radiated power. On the other hand as the measurements cannot be carried out in a great number of directions both horizontally and at various inclinations, it is considered suitable to admit as an hypothesis, that in each vertical plane F and H vary proportionately to $\sin \theta$ as expressed in (4). It follows from this and (5) that the element of radiation dP_i in the sector of horizontal aperture $d\alpha$ is

$$dP_i = \frac{8\pi}{3} \sqrt{\frac{\mu}{\epsilon}} \left(\frac{h}{\lambda}\right)^2 I^2 d\alpha,$$

and therefore calculating h or R_i for every sector, we get the mean value h_m or of R_{im} from the relations :

$$h_m = \sqrt{\frac{1}{2\pi} \int_0^{2\pi} h^2 d\alpha} \quad \text{and} \quad R_{im} = \frac{1}{2\pi} \int_0^{2\pi} R_i d\alpha \quad . . . \quad (15)$$

which introduced in (5) in their turn allow us to estimate the radiated power P_i .

10. Influence of the Wavelength.—In the case of the half Hertzian dipole (to which equations (4) refer), the height h is a well-defined geometrical dimension, independent of the oscillations which are generated in it. On the contrary, in the case of ordinary aerials, it must be pointed out that the radiation height h , defined precisely as the height of the equivalent dipole, depends on the distribution of the current in the aerial, and therefore also on the wavelength used. In fact, even limiting ourselves to the consideration of the case of an aerial with negligible horizontal dimensions as compared with λ and without any directive properties, it is necessary to apply (4) to each element of height dh and therefore to substitute for the product Ih the

integral $\int_0^{h'} I_h dh$ extended to the whole geometric height h' of the aerial.*

It follows that the effective height which is defined precisely by

$$Ih = \int_0^{h'} I_h dh \quad \quad (16)$$

depends on the law of distribution of $I_h = f(h)$, which in its turn depends in general on the wavelength. This is easily found for a simple vertical aerial (Fig. 4), for which it has already been mentioned (par. 4) how in the case of oscillation with the natural wavelength the distribution of the capacity and of the self-inductance along the conductor being assumed uniform, we get

* It is understood that if between two horizontal planes placed at a distance dh one from the other, there are included several conductors belonging to the aerial, I_h must be put equal to $\Sigma(I)$, adding algebraically the values of the current in each of the single conductors.

$h = \frac{2}{\pi} h'$ because $I_h = I \cos \frac{\pi}{2} \cdot \frac{h}{h'}$. Now, when in the place of the natural oscillation λ_0 one produces an oscillation (for example by inserting between the base of the aerial and the earth a self-inductance L) of a greater wavelength λ , the distribution of I_h is represented by :

$$I_h = I \frac{\sin \frac{\pi \lambda_0 h' - h}{2 \lambda}}{\sin \frac{\pi \lambda_0}{2 \lambda}} \dots \dots \dots (17)$$

from which with (16) the effective height

$$h = \frac{2}{\pi} h' \frac{\lambda}{\lambda_0} \left(\frac{1 - \cos \frac{\pi \lambda_0}{2 \lambda}}{\sin \frac{\pi \lambda_0}{2 \lambda}} \right) \dots \dots \dots (18)$$

is deduced, which includes as a particular case for $\lambda = \lambda_0$ the effective height $\frac{2}{\pi} h'$, and gives ever decreasing values of h as λ increases, reaching its minimum value $h'/2$ for the case of $\lambda_0 \ll \lambda$.*

It is seen, therefore, that while in the half dipole the effective height is constant as λ varies, and is equal to the geometric height h , in the linear half oscillator it progressively decreases as λ increases from $0.64h$ to $0.50h$. In aerials of the ordinary type, generally something intermediate takes place, because in them the designer tries to concentrate the capacity in one more or less horizontal part placed as high as possible, whereas the inductance is provided mainly by the lead-down or tail, which connects that capacity with the earth through the exciting appliances or receivers. However, the conditions of the half dipole cannot be realised in connection with the relation between the effective height h and the maximum geometric height of the aerial h' , and this owing to the effect both of the sag of the conductors constituting the upper network, as well as of the capacity inevitably distributed also along the down-leads, and finally on account of the causes of local absorption (par. 11). Therefore, as a general rule, values of h/h' which vary between 0.6 and 0.7 are found for non-directive aerials.

As to the variation with the wavelength, it is generally very small owing to the fact that generally considerably greater wavelengths are used than the natural one for which even in the case of a linear aerial the variations of h with those of λ are very small.

* The discussion of the formulæ can be extended even to the case in which an oscillation is produced with a wavelength $\lambda < \lambda_0$ (for example by inserting a capacity at the base of the aerial). In this case values of h increasing as λ decreases are calculated up to values which may turn out very great when λ approaches $\lambda_0/2$. Nor must this appear strange when we remember that in this case the current I at earth connections is no longer the maximum effective value which is found along the aerial, because the curve of the current is displaced upwards and the value of I tends to zero (whatever may be the oscillatory power called into play) when λ approaches $\frac{\lambda_0}{2}$.

11. Influence of the Supports of the Sending Antenna.—On the basis of what has been set forth above, the radiation height of an aerial is shown to depend on its geometric figure and to a small extent also on the wavelength of the oscillation of which it is the source. In reality another important element appreciably affects the value of the height h , as calculated by (13) and (14) on the basis of measurements executed at a certain distance, d . This arises through all those causes, which give rise, through the earth connection, to the passage of currents which although contributing to the value of I measured and introduced in the formulæ, do not, however, contribute to the radiation. These causes lie in all the local circuits in which the aerial oscillation acting by direct induction (electrostatic or electromagnetic) induces other secondary oscillations which always present a component in opposition of phase and therefore attenuate the action at a distance, or which comes to the same thing, reduce the effective height. Among such local circuits, which are represented by every more or less conductive material situated in the field of the aerial, the mast structures and their stays take the foremost place. The power which they absorb depends on their shape, on their position with respect to the aerial and on their electrical resistance. To reduce these losses recourse is had in varying measure, to subdividing the conducting bodies (and especially the stays) by interposing insulators, to the separation of the metal structures from earth by basal insulators, to the more or less partial use of wood instead of iron, to a suitable examination of the reciprocal position of the aerial and its supports, to the elimination as far as possible of conducting masses from the proximity of the aerial circuit and so on. Another cause of the increase of the current I without a corresponding increase of radiation may arise through the presence of capacities between the lowest portion of the aerial down-leads and the earth due to their passage through the walls of the buildings, and to the supporting and holding insulators.

In connection with the phenomena just mentioned, many experiments have demonstrated for example, that substituting continuous stays for stays subdivided by insulators, stretching metal conductors along wooden supports, or connecting to earth metallic supports, which were previously insulated, we can indeed get an increase of the current I in the sending antenna (at equal excitation), but there is also such a considerable decrease of h , that usually the radiated power is reduced. Especially in the case of metal masts previously insulated from the ground and then connected to it through a variable resistance, it is found that there is in general a critical value of such a resistance, with which the unfavourable action from the point of view of radiation, attains a maximum. Systematic experiments are in progress for the deduction of rational criteria for the insulation of the base of masts and for the distribution of insulators along the stays.*

(To be concluded.)

* Quite apart from what has been stated in this note, the question of the radiation from aircraft aeriels or from aeriels placed on the ground, on the water, or actually immersed to a certain depth, deserves a separate study. These types of aeriels are found in conditions remarkably different to those considered for ordinary aeriels.

The Effect of Modulation Waveshape upon Received Signals.*

By A. S. BLATTERMAN

(Radio Engineer, Signal Corps, U.S. Army).

There are several waveshapes of modulation employed in radio communication. For example, we have the logarithmic modulation of spark transmitters as in Fig. 1 (a), the chopped modulation of chopper sent continuous waves (Fig. 1 (b)), sine modulation as produced by a pure tone on a radio telephone transmitter (Fig. 1 (c)), or interrupted sine modulation (Fig. 1 (d)), as obtained from continuous wave transmitters using A.C. plate voltages, etc.

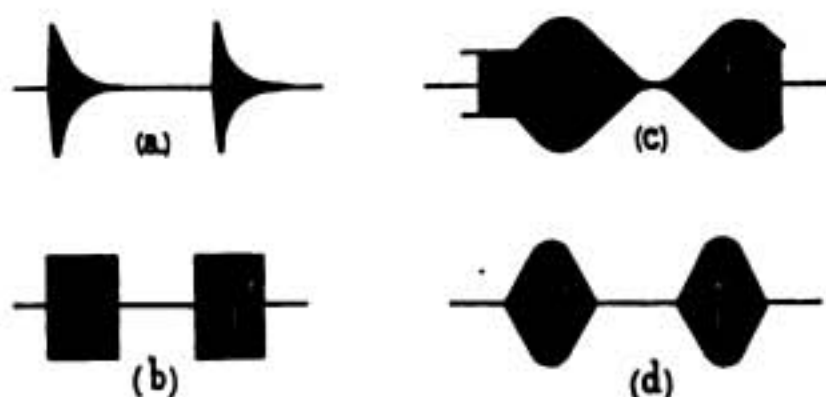

FIG. 1.

Not all of these modulation waveshapes are equally effective. If, in each case, the R.M.S. current in the transmitting antenna is the same, it will be found that the strength of signal received at a distance favours certain of these modulations over others. Distortion is also important, and more pronounced with some kinds of modulation than others. It is the purpose of the present paper to indicate the extent of these distortions and to give first an approximate comparison and later a more accurate, although somewhat more cumbersome, method for comparing the signal strength produced by various waveshapes of modulation with given R.M.S. antenna current at the transmitter.

NATURE OF THE DISTORTION EFFECT.

A qualitative understanding of the distortion effect may be clearly had by calling attention to the well-known difference between the envelope curves of oscillating current in primary and secondary of a pair of coupled spark excited circuits, and the rectified audio frequency telephone current in the detector of a receiving circuit. As is well known, a spark discharge in the primary of a pair of tuned circuits very loosely coupled gives current oscillations which can be represented by the curve of Fig. 2 (a), while in the secondary the current oscillation follows more nearly a curve like that of Fig. 2 (b).

* Received November 18th, 1920.

The two circuits may be thought of as the transmitting and receiving antennas respectively, and it becomes evident at once that the envelope curve of the received current is not at all a replica of that transmitted. The detector at the receiver produces a further change in waveshape owing to its non-linear rectification characteristic so that the sound ultimately produced in the telephone receivers, while characteristic of the transmitted spark note, is not by any means an exact reproduction of it.

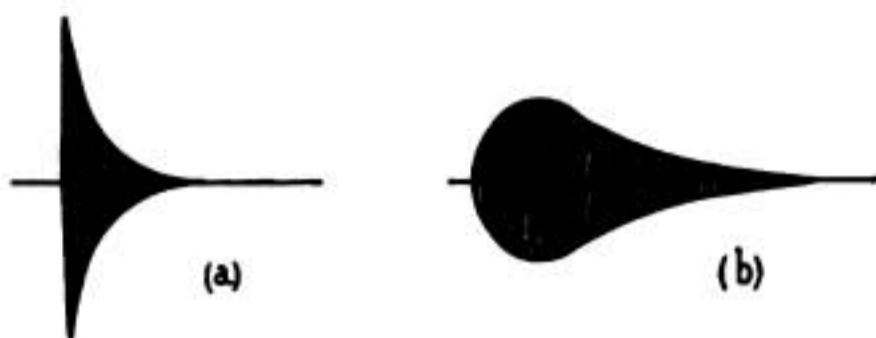

FIG. 2.

A quantitative estimate of the distortion effect attributable to the detector may be readily obtained by consideration of the change in waveshape of a pure sinusoidally modulated oscillation applied to the detector. Such an oscillation is represented in Fig. 3 ; and its equation is—

$$e = A \sin \omega t + B \sin pt \sin \omega t \dots \dots \dots (1)$$

p being the modulating audio frequency periodicity and ω the carrier radio frequency periodicity. The detector characteristic, Fig. 4, can be represented by the equation

$$i = a_1 e + a_2 e^2 + \dots \dots \dots (2)$$

in which terms of higher order than the second may be neglected with most

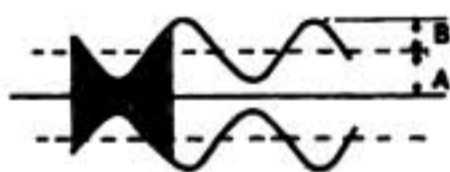

FIG. 3.

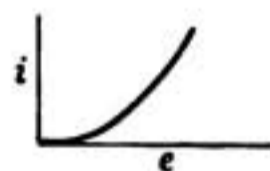

FIG. 4.

forms of detectors in common use. If the value of e from (1) is substituted in (2) the detected current becomes

$$i = \frac{a_2}{2} \left(A^2 + 2AB \sin pt + \frac{B^2}{2} - \frac{B^2}{2} \cos 2 pt \right) + \text{Radio frequency terms} \dots (3)$$

It is seen that a term of double frequency with amplitude $\frac{B^2}{2}$ has been introduced by the action of the detector. This term produces distortion and the waveshape changes from the original sine wave of modulation to something resembling the heavy line of Fig. 5.

In order to illustrate the distortion which occurs in the tuned radio

m

frequency receiving circuits we may again take the relatively simple case of a sinusoidally modulated transmission of the type shown in Fig. 3. This, it will be observed, is now supposed to be the current in the transmitting antenna. The equation is of the form of (1).

$$i_s = A_s \sin \omega t + B_s \sin pt \sin \omega t \dots \dots \dots (4)$$

The instantaneous electromotive force produced by this current in a distant receiving antenna will be

$$e_r = ki_s = k (A_s \sin \omega t + B_s \sin pt \sin \omega t) \dots \dots \dots (5)$$

This may be written

$$e_r = k \left\{ A_s \sin \omega t + \frac{B_s}{2} \cos (\omega - p)t - \frac{B_s}{2} \cos (\omega + p)t \right\} \dots \dots (6)$$



FIG. 5.

showing that the received voltage comprises components having three different radio periodicities, the carrier ω , one higher $(\omega + p)$ and one lower $(\omega - p)$. The receiving circuits are tuned to the carrier frequency ω and

the two side frequencies corresponding to $(\omega + p)$ and $(\omega - p)$ are therefore off tune. Each of the component voltages present will force current through the circuit and the total current will thus be the sum of three components having the different frequencies of the driving E.M.F.'s. The tuned component (ω) will experience impedance which is entirely resistive. The side frequency components find impedances involving not only the resistance of the receiving antenna but also some reactance. The side frequency of higher frequency will be retarded in phase while the lower side frequency will be advanced. The current equation thus becomes

$$i_r = k \left\{ \frac{A_s}{r_r} \sin \omega t + \frac{B_s}{2Z_r'} \cos [(\omega - p)t + \phi'] - \frac{B_s}{2Z_r''} \cos [(\omega + p)t - \phi''] \right\} \dots (7)$$

where

$$\phi' = \cos^{-1} \frac{r_r}{Z_r'}$$

$$\phi'' = \cos^{-1} \frac{r_r}{Z_r''}$$

$$Z_r' = \frac{1}{\sqrt{r_r^2 + \left[(\omega - p)L - \frac{1}{(\omega - p)C} \right]^2}}$$

$$Z_r'' = \frac{1}{\sqrt{r_r^2 + \left[(\omega + p)L - \frac{1}{(\omega + p)C} \right]^2}}$$

- r_r = resistance of receiving antenna.
- L = inductance " "
- C = capacity " "

If the expressions for Z' and Z'' are expanded and the approximation used that

$$\frac{1}{1 \pm \frac{p}{\omega}} = 1 \mp \frac{p}{\omega}$$

it is seen that

$$\begin{aligned} Z_r' &= Z_r'' = Z' \\ &= \sqrt{r_r^2 + 4p^2L^2} \\ \phi' &= \phi'' = \phi \\ &= \cos^{-1} \frac{1}{\sqrt{1 + \frac{4p^2L^2}{r_r^2}}} \\ &= \cos^{-1} \frac{1}{\sqrt{1 + \frac{4p^2}{\omega^2} \cdot \frac{\pi^2}{\delta_r^2}}} \end{aligned}$$

where δ_r = decrement of receiving circuit. Equation (7) for the received current now takes the simpler form

$$\begin{aligned} i_r &= \frac{k}{r_r} \left\{ A_s \sin \omega t + \left(\frac{B_s}{2} \cos \phi \right) \cos [(\omega - p)t + \phi] - \right. \\ &\quad \left. - \left(\frac{B_s}{2} \cos \phi \right) \cos [(\omega + p)t - \phi] \right\} \\ &= \frac{k}{r_r} \left\{ A_s \sin \omega t + [B_s \cos \phi] \sin (pt - \phi) \sin \omega t \right\} \dots \dots \dots (8) \end{aligned}$$

By comparison of this equation with (5) for the transmitted current it is seen that the received current is similar in form but is modulated to a lesser extent than that transmitted, by the factor $\cos \phi$. The phase of the modulation is also retarded at the receiver by angle ϕ . It is evident that if the modulation at the transmitter were not sinusoidal as in the case just discussed but of irregular waveshape as generally occurs in practice, each of the harmonics of the irregular wave would undergo a different relative change in amplitude and a different phase shift upon being established in a receiving antenna. This obviously would produce distortion, and also affect the strength of signal.

In order to indicate the magnitude of the effect Table I. has been calculated for 1,000 cycle sine modulation of a 600 metre wave with different receiver decrements. It is seen that if a receiving circuit with decrement $\delta_r = 0.02$ is used to receive this wave the modulation will only be 85 per

cent. of that at the distant transmitter. The result is shown graphically for 100 per cent. transmitter modulation in Fig. 6.

TABLE I.

δ_r	$\cos \phi$
0.005	0.369
0.01	0.62
0.02	0.85
0.04	0.955
0.10	0.99

STRENGTH OF SIGNAL.

Approximate Method.

It has frequently been shown that the detecting current for spark signals on a non-oscillating detector is proportional to the square of the R.M.S. received antenna current. A spark signal is a completely modulated wave, that is the oscillation current comes to zero for a certain portion of the audio

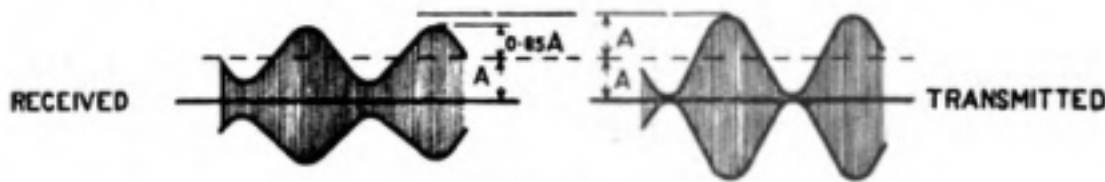

FIG. 6.

frequency cycle. After proving that this relation between detecting current and mean square antenna current holds good also in the case of pure sine modulation provided the modulation is complete, and calculating the deviation from this proportionality when the modulation is not complete, it will be assumed that the mean square received antenna current may be taken as a basis for comparison of all waveshapes of modulation. A direct comparison of the antenna currents squared will be used in all cases where the envelope modulation curve comes to zero during the audio cycle, that is complete modulation, and when the modulation is incomplete a correction factor will be applied.

Sine Modulation.

The detecting current in this case can be readily calculated with accuracy, and it is now desired to compare its actual value with that figured from the square of the R.M.S. antenna current. The received current and the detector voltage * have the forms

$$i = A \sin \omega t + B \sin pt \sin \omega t \dots \dots \dots (9)$$

$$e \cong mi = mA \sin \omega t + mB \sin pt \sin \omega t \dots \dots \dots (10)$$

* See p. 151, last paragraph.

The detector voltage (10) gives in the telephone circuit detecting current

$$i_d = \frac{a_2 m^2}{2} \left(A^2 + 2AB \sin pt + \frac{B^2}{2} - \frac{B^2}{2} \cos 2pt \right) + \text{radio frequency terms}$$

as was shown above (equation (3)). Of this the audio frequency signal component is

$$i_a = \frac{a_2 m^2}{2} \left(2AB \sin pt - \frac{B^2}{2} \cos 2pt \right)$$

The effective value of this is

$$aI_{\text{eff.}} = \frac{a_2 m^2 B}{\sqrt{2}} \sqrt{A^2 + \frac{B^2}{16}} \dots \dots \dots (11)$$

It is to be noted that in this calculation the terms of higher order than the second in equation (2) for the detector characteristic have been neglected so that actually the value of $aI_{\text{eff.}}$ will be slightly larger than that given by (11).

Using the mean square antenna current as basis for calculation of detecting current we use the impressed voltage (10) and detection factor a_2 and obtain

$$aI'_{\text{eff.}} = a_2 E^2_{\text{eff.}} = a_2 m^2 \frac{A^2}{2} \left(1 + \frac{B^2}{2A^2} \right) \dots \dots \dots (12)$$

Letting $K = \frac{B}{A}$ = percentage modulation of received antenna current, we

thus find the ratio of actual detecting current (11) to the value calculated from mean square antenna current (12) as

$$\sigma = \frac{aI_{\text{eff.}}}{aI'_{\text{eff.}}} = \frac{\sqrt{2} K \sqrt{1 + K^2/16}}{1 + \frac{K^2}{2}} \dots \dots \dots (13)$$

The value of this ratio is drawn for different values of K in Fig. 7 where it is seen that for $K = 1$, *i.e.*, complete modulation, σ is practically unity,* although when the modulation is not complete ($K < 1$) the ratio quickly decreases. This means that for cases where complete modulation is obtained comparison of detected currents can be made directly by comparison of mean square received antenna currents, but for incomplete modulation the antenna current squared must be multiplied by a correction factor as given by (13) or Fig. 7, in order to get figures for comparison of signal strength.

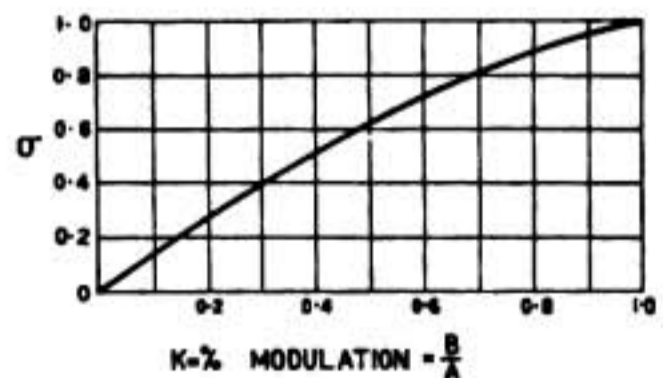

FIG. 7.

* It would probably be exactly unity if the higher order terms of the detector equation had not been ignored.

THE GENERAL CASE.

Whatever the modulation wave-form of transmitting antenna current, *i.e.*, logarithmic as in spark transmission, sinusoidal, chopped, telephonic, etc., it can in general be represented by the expression :

$$i_s = I_0 \left\{ S_0 + S_1 \sin (pt + \theta_1) + S_2 \sin (2pt + \theta_2) + \dots \right\} \sin \omega t \quad (14)$$

The bracketed expression being the Fourier sines representative of the envelope curve of modulation and I_0 being the maximum value of this curve. See Fig. 8.

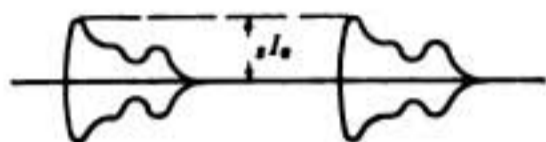

FIG. 8.

The problem is to determine the effect of different modulation waveshapes at the transmitter upon signal strength and quality, the R.M.S. current in the sending antenna being the same in all cases.

The R.M.S. transmitting antenna current is obtained from (14) as

$$I_s = I_0 \sqrt{\frac{S_0^2}{2} + \frac{S_1^2}{4} + \frac{S_2^2}{4} + \frac{S_3^2}{4} + \dots} \quad (15)$$

Equation (14) can be re-written in the form

$$i = I_0 \left\{ S_0 \sin \omega t + \frac{S_1}{2} \cos [(\omega - p)t - \theta_1] - \frac{S_1}{2} \cos [(\omega + p)t + \theta_1] + \dots \right.$$

$$\left. + \frac{S_2}{2} \cos [(\omega - 2p)t - \theta_2] - \frac{S_2}{2} \cos [(\omega + 2p)t + \theta_2] + \dots \right.$$

This equation shows the sending current to be made up of numerous constituents comprising a carrier frequency ω and side frequencies above and below this respectively with values

$$\omega \pm p_1 \quad \omega \pm 2p_1 \quad \omega \pm 3p_1 \dots$$

The receiving antenna being tuned to the carrier frequency ω tends more or less to suppress the side frequencies and also causes changes in phase, as was explained above in connection with equation (7). The received current becomes, with these circumstances in view,

$$r_i = \frac{k I_0}{r_r} \left\{ S_0 \sin \omega t + \frac{S_1}{2} \cos \phi_1 \cos [(\omega - p)t - \theta_1 + \phi_1] - \dots \right.$$

$$\left. - \frac{S_1}{2} \cos \phi_1 \cos [(\omega + p)t + \theta_1 - \phi_1] + \dots \right.$$

$$\left. + \frac{S_2}{2} \cos \phi_2 \cos [(\omega - 2p)t - \theta_2 + \phi_2] - \dots \right.$$

$$\left. - \frac{S_2}{2} \cos \phi_2 \cos [(\omega + 2p)t + \theta_2 - \phi_2] + \dots \right\} \quad (16a)$$

$$= \frac{k_s I_0}{r_r} \left\{ \begin{aligned} &S_0 + [S_1 \cos \phi_1] \sin (pt - \phi_1 + \theta_1) + \\ &+ [S_2 \cos \phi_2] \sin (2pt - \phi_2 + \theta_2) + \\ &+ [S_3 \cos \phi_3] \sin (3pt - \phi_3 + \theta_3) + \\ &+ \dots \end{aligned} \right\} \sin \omega t \dots \dots (16b)$$

where
$$\phi_n = \cos^{-1} \frac{1}{\sqrt{1 + \frac{4\pi^2}{\delta_r^2} \cdot \left(\frac{np}{\omega}\right)^2}}$$

Following the procedure indicated above we are to take the square of the effective current (16) as a measure of signal strength. This is

$$r_e I_e^2 = \frac{k^2 s I_0^2}{r_r^2} \left\{ \frac{S_0^2}{2} + \frac{S_1^2 \cos^2 \phi_1}{4} + \frac{S_2^2 \cos^2 \phi_2}{4} + \frac{S_3^2 \cos^2 \phi_3}{4} + \dots \right\} (17)$$

which with the help of (15) becomes

$$r_e I_e^2 = \frac{k^2 s I_0^2}{r_r^2} \left\{ \frac{S_0^2}{2} + \frac{S_1^2 \cos^2 \phi_1}{4} + \frac{S_2^2 \cos^2 \phi_2}{4} + \frac{S_3^2 \cos^2 \phi_3}{4} + \dots \right\} (18)$$

$$= \text{Constant} \times \left\{ \frac{S_0^2}{2} + \frac{S_1^2 \cos^2 \phi_1}{4} + \frac{S_2^2 \cos^2 \phi_2}{4} + \dots \right\} \dots \dots (19)$$

For different modulations giving correspondingly different values of $S_0, S_1, S_2, S_3 \dots, \phi_1, \phi_2, \phi_3 \dots$, we therefore compare terms of the form of the term of (19) within brackets in order to determine relative signal strengths. Several concrete cases of importance as arising in practice will now be compared in this way.

It should be noted that the impressed detector voltage originating across the tuning condenser is, from (16a),

$$e = \frac{k_s I_0}{r_r} \left\{ \begin{aligned} &\frac{S_0}{\omega C} \sin (\omega t + 90^\circ) + \frac{[S_1 \cos \phi_1]}{2(\omega - p)} \cos [(\omega - p)t - \theta_1 + \\ &+ \phi_1 + 90^\circ] - \frac{[S_1 \cos \phi_1]}{2(\omega + p)} \cos [(\omega + p)t + \\ &+ \theta_1 - \phi_1 + 90^\circ] + \dots \end{aligned} \right\} \dots (16c)$$

and since $p, 2p, 3p, 4p$, etc. are very small compared with ω the expression becomes practically identical in form with the current (16a) and (16b), that is, the relative amplitude of the several harmonic constituents of the envelope curve is the same for the detector voltage as for the received current.

(To be concluded.)

The Physical Society's Exhibition.

A Description of the Exhibits (continued from page 97).

MR. J. ST. VINCENT PLETTS exhibited his new pattern of slide rule, now known as the "Davis-Pletts Slide Rule."

This slide rule has (besides a number of minor modifications) two novel features, which greatly extend the usefulness of the instrument for dealing with the mathematical functions so often met with in radio and other physical problems. In the majority of the slide rules now on the market that are provided with log-log scales, the scale is non-recurring and is usually made two or three times the length of the rule so that confusion often arises as to what part of the scale is being used. In the Pletts rule the range of the log-log scale is indefinitely extended by making use of the properties of the characteristics and mantissæ of common logarithms to base 10. Fig. 4 shows the general arrangement of the scales on the rule and on the back of the slide. The common logarithms can thus be read directly from these scales, all that is necessary being to add the appropriate characteristic. If it be desired to raise any number to any power one proceeds in the usual way, but if the result is greater than 10 the other end of the slide can be used, and the decimal point moved correspondingly. A second novel feature is the provision on the slide of scales for all the ordinary exponential, circular and hyperbolic functions, arranged to read on the same log scale, so that the product or ratio of any such functions can easily be obtained. Along the front of the slide an equally divided scale is arranged to give $a\epsilon^x$, ϵ^x and $\log ax$. In combination with the scales on the back of the slide all such functions as $\epsilon^n \sin x$, and $\log n \cosh x$ can be obtained with a single setting of the slide and cursor, while every combination of the various functions is obtainable with two or more settings.

(To be continued.)

Notes.

Personal.

Dr. J. Zenneck, Professor of Experimental Physics at the Technische Hochschule at Munich, has been elected a member of the Bavarian Academy of Learning. [2008]

Frank Conrad, Consulting Engineer to the Westinghouse Electric and Manufacturing Co., of East Pittsburgh, U.S.A., has been appointed Assistant Chief Engineer to that company. Mr. Conrad has been connected with the Westinghouse Co. for almost thirty years. The aircraft radio apparatus developed to the designs of Mr. Conrad during the war, was the only U.S. equipment of its kind which reached France in any quantity. [2168]

M. Léon Bouthillon has been awarded the Hebert prize by the Paris Academy of Sciences for his work and publications on wireless telegraphy. [2109]

The Edison medal for the year 1920 has been awarded by the American Institute of Electrical Engineers to Mr. M. I. Pupin for his physical and mathematical work. This medal is awarded annually for the best work of an electrical nature whether of technical or industrial application. [2071]

Commercial.

A NEW THREE-ELECTRODE VALVE.—The Radio Corporation of America announces the introduction of a new pattern of three-electrode vacuum tube, designated Radiotron U.V. 200,

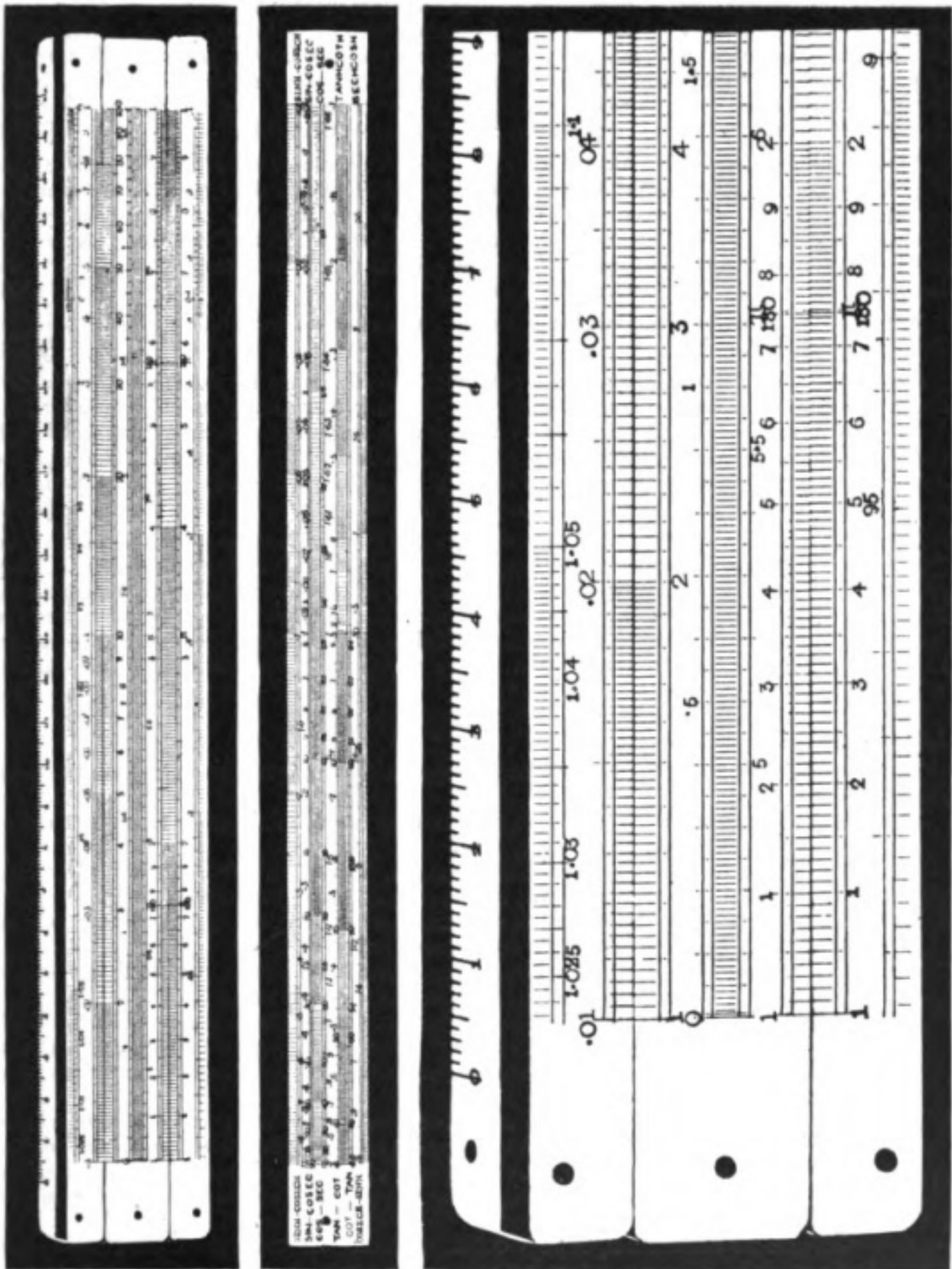

FIG. 4.—The “Davis-Pletts” Slide Rule, showing front view of rule, and back of slide; also an enlarged view of part of the rule.

which is specially designed for the use of wireless amateurs and experimenters. The new tube is not of the extremely "hard" variety, and is consequently best suited for a low value of plate voltage (about 18 volts usually), and makes a good detecting valve. The best values of the grid condenser and leak are stated to be about 0.00025 μ F and 0.5 megohm respectively. The tube is also suitable for note-magnifiers or low-frequency amplifiers, but if more than two stages are required in cascade, it is recommended that all valves after the first should be of a "harder" type—such as "Radiotron U.V. 201." [2170]

NEW WIRELESS STATIONS.—The Federal Wireless Telegraph Co., of San Francisco, has signed a contract to erect powerful wireless stations at Shanghai, Peking and Harbin at a cost of \$4,200,000. It will be a joint Chino-American operation to be controlled by the Ministry of Communications; after ten years the system will revert to China. A protest has been entered against this contract on the ground that it violates one made with the English Marconi Co. (See note on page 41.) [1996]

The Australian wireless coast station at Roebourne was closed for public correspondence on February 7th, 1921. [2172]

HIGH VOLTAGE ACCUMULATORS.—In a pamphlet recently issued by the Hart Accumulator Co., Ltd., particulars are given of the high voltage accumulator units manufactured by that firm. The sets are manufactured primarily for use with thermionic valve amplifiers, although they may obviously also be employed for many electrical testing purposes. The cells are contained in waxed teak boxes, and each cell is fitted in an ebonite box of special design to ensure high insulation. The sets are made up in 50 volt units. [2171]

Messrs. Newton & Co., Ltd., have recently prepared a set of lantern slides for a lecture on "Wireless Telegraphy" dealing more particularly with the Elwell-Poulsen system. They are accompanied by a full set of notes, which provide alternative methods of treatment for audiences of varying degrees of acquaintance with the subject. Many of the slides are from hitherto unpublished photographs and we think should prove both interesting and useful to many of our readers. Messrs. Newton & Co.'s address is 37, King Street, Covent Garden, W.C. 2.

Legal.

The following changes in the existing radiotelegraph message rates and coast taxes have recently been notified:—

SWEDEN AND DENMARK: Coast tax 40 centimes per word, minimum 4 francs per radiotelegram, commencing January 1st, 1921.

NORWAY: Stations at Bergen, Flekkeroy, Sorvagen, Tjome, and Utsire, coast tax 40 centimes per word with minimum of 4 francs. Commenced January 1st, 1921.

STRAITS SETTLEMENTS: The coast tax of radio stations at Penang and Singapore was increased to 60 centimes per word on January 1st.

TRINIDAD: On and after November 30th, 1920, a charge of 4 cents per word is made to cover the cost of delivery of messages outside the town of Port of Spain.

MADAGASCAR: On October 1st last the interior tax applicable to radiotelegrams which originate in or have their destination in Madagascar (including the Comore Islands) and exchanged directly with the coast stations of Madagascar and of the Comores has been fixed at 20 centimes per word.

NEW YORK: From February 1st, the coast tax through the WNY radio station will be increased to 10 cents per word. A new station is also to be erected on Cape Cod (the sending station to be located at Marion, Mass., and the receiving station at Chatham, Mass.). It will be completed within the next month. The coast station tax will be 10 cents per word.

The rate for radio messages from U.S.A. to Great Britain *via* the transatlantic radio stations has been increased from 17 to 18 cents per word.

U.S.A.: The coast station rate of the Naval Radio Station at Norfolk, Virginia, will be increased to 10 cents per word from March 15th, 1921.

FRANCE: A charge of 6 francs for each radiogoniometric bearing taken by a French land station at the request of a ship station will be made. This tax came into force on December 1st last.

BELGIUM: The Belgian Telegraph Administration will apply a tax over the telegraph lines

of Belgium for radiotelegrams originating in or destined for Belgium, and exchanged directly with Belgian coastal radio stations of fifteen centimes per word, with a minimum of 1 franc 50 per radiotelegram. For urgent radiotelegrams these charges will be 45 centimes, and 4 francs 50 respectively. These revised charges came into force on December 15th, 1920.

RADIO TRAFFIC ARRANGEMENTS.—From October 15th, 1920, the hours of service of the Weltvreden Radio Station (Dutch East Indies) are as follows: Weekdays, 6 a.m. to 11 p.m., Sundays and holidays, 9 a.m. to 12 noon, and 2 p.m. to 5 p.m.

The British Post Office radio station at Devizes (call letters GKU) is now open for continuous wave communication with ships, on a wavelength of 2,100 metres. The station will normally be open at all times for the receipt of messages from ships, but will as a rule only call ships during the following periods: 1 a.m. to 1.30 a.m., 5 a.m. to 5.30 a.m., 9 a.m. to 9.30 a.m., 1 p.m. to 1.30 p.m., 5 p.m. to 5.30 p.m., 9 p.m. to 9.30 p.m. G.M.T. The station will not however be available for communication during periods of three minutes commencing at 15 and 45 minutes past every hour (G.M.T.) as ships using wavelengths other than 600 metres are required during these periods to keep watch on a wavelength of 600 metres. The message rates are the same as those for messages through other British coast stations.

The radio station at Havana, Cuba (call letters PWA), will transmit daily at 12.30 a.m., 75th meridian time, (5.30 a.m. G.M.T.) long distance messages destined for vessels at sea. A wavelength of 2,150 metres is employed, and a power of 10 kW in the antenna. [2166]

General.

A NEW ARRANGEMENT OF DIRECTION FINDER.—We have received some interesting particulars of a recent patent application by Mr. F. Murphy, No. 1101/1920, which deals with improvements in direction finding. The essential idea consists in erecting a number of aerials at suitable angular displacements and supplying each aerial with high frequency oscillations which are modulated at a lower frequency, the phase of modulation for each aerial being appropriate to its angular displacement. Thus if three aerials are used displaced at angles of 120° the phase displacements of the currents supplied to modulate the radiations from these oscillations will also be 120° . The resultant effect is the production of a directional field of radiation from the combined aerials in which the direction of maximum intensity rotates at the modulation frequency. The arrangement is thus applicable for "radiophare" work, and avoids the necessity of rotating the aerial system or other parts of the apparatus. [2169]

HIGH-TENSION INSULATORS FOR SUPPORTING AERIALS.—The question of aerial insulation for high-power stations is a very difficult one and is in fact limiting the output of some well-known stations at the present time. Hitherto it has been necessary to employ strings of eight or ten ordinary suspension type insulators as used on transmission lines. At wireless frequencies these have quite an appreciable capacity, and when broken up after having been in service, a blue discoloration can be seen right through the porcelain as a result of the passage of charging current. The voltage distribution for the string is of course not uniform and there are frequent breakdowns. It is interesting therefore to have some particulars of a new insulator which is being put into use at the G.P.O. stations at Abu Zabal, Leafield and Northolt, and which promises to solve this important problem. These insulators consist of porcelain rods or tubes up to 5 feet in length and having a diameter of about 4 inches. They are held in tension; their electrostatic capacity is therefore extremely small. Their flash over voltage is beyond the capacity of any testing transformers at present available, even under standard rain tests with a precipitation of 1 inch of rain in five minutes on the insulator. Flux distributing rings of about 21 inches diameter are fitted on the aerial end of the insulators and porcelain drip rings are cemented to the porcelain to break up the flow of very heavy rain.

In addition their weight is less than the equivalent of ordinary insulators, and their cost is also lower. The use of porcelain in tension is of course an unusual step, but we understand that a number of such insulators have been in use at various places, and those at present being made for the G.P.O. are being tested with a load of 10,000 lbs. before being put into service. Such a test demands a very high grade of porcelain with an entire absence of flaws and departure from the straight. They are being manufactured by Messrs. Bullers, Ltd., of Hanley, Staffs.

Review of Radio Literature.

1. Abstracts of Articles and Patents.

Radio Stations and Installations (General and Descriptive Articles).

1542. The Inauguration of the Paris Radio Central. (*Radioélectricité*, 1, pp. 369—377, January, 1921.)

Describes the ceremony of the laying of the foundation-stone of the new Radio Central near Paris on January 9th, 1921. The texts of the inaugural speeches are given. (See also pp. 125—133 in this issue.)

1543. The Role of the Paris Radio Central. (*Radioélectricité*, 1, pp. 378—392, January, 1921.)

This article outlines the insufficiency of French cable communications, the inadequacy of the existing radio stations to cope with all the available traffic and the need for further high-power stations. A number of illustrations are given of French high-power stations, and also of the works wherein the various parts (high-frequency alternators, etc.) are manufactured. (See also pp. 125—133 in this issue.)

1544. The Large French Radio Centre. (*Radioélectricité*, 1, pp. 393—403, January, 1921.)

Many details are given of the proposed high-power radio station for Paris. (See preceding abstracts, and pp. 125—133 in this issue.) A double-page sketch-view is included indicating the probable appearance of the completed stations.

1545. The Inauguration of the London-Paris Radio Service. (*Radioélectricité*, 1, pp. 404—408, January, 1921.)

See p. 133 in this issue.

1546. H. Thurn. The Wireless Installation on the *Imperator*. (*Jahrbuch Zeitschrift für drahtlose Telegraphie*, 15, p. 480, June, 1920. Abstracted from *Elektrotechnik und Maschinenbau*, 32, p. 251, 1914.)

1547. German Wireless Network. (*Telegraphen- und Fernsprech-Technik*, 9, p. 149, December, 1920.)

An official account of the recent developments in the wireless network which is being developed throughout Germany by the postal authorities. Successful tests with high-speed automatic systems having been made, this will now be introduced in several of the stations.

1548. H. de Gallaix. New Radio Station at Lyons, France. (*Radio Amateur News*, 1, pp. 464—465, March, 1920.)

A general description of the station is given.

1549. A. Gradenwitz. New Facts about the Nauen Station. (*Radio Amateur News*, 1, pp. 560—561, April, 1920.)

1550. A. F. Wallis. The Otto Cliffs Naval Receiving Station. (*Radio News*, 2, pp. 6—7, July, 1920.)

An illustrated description.

1551. R. Wilhelme. Radio in Germany. (*Radio News*, 2, p. 8, July, 1920.)

1552. A. H. Lynch. An Amateur Station operated on a Commercial Scale. (*Radio News*, 2, pp. 143, 170—174, September, 1920.)

A description of the installation at the offices of the *New York Times*.

1553. Belmar Wireless Station. (*Radio Nieuws*, 3, pp. 226—228, August, 1920.)

A brief description of this station.

1554. Dual System of Radio on Pacific Ships. (*Wireless Age*, 8, p. 8, October, 1920.)

Reference is made to the installation of combined radiotelegraph and telephone instruments on a number of Pacific vessels having contracts with the **Radio Corporation of America**.

1555. A Wireless Outfit for Small Vessels. (*Electrical Review*, 87, pp. 413—414, September 24th, 1920.)

A short illustrated description of a ship's cabinet wireless installation manufactured by Messrs. Siemens Brothers and Company, Woolwich.

1556. Japanese Radio Apparatus. (*Radio News*, 2, p. 72, August, 1920.)

1557. A. J. Hall. Radio in Modern Aircraft. (*Radio Amateur News*, 1, p. 539, April, 1920.)

1558. Pedal-driven Wireless Sets. (*La Nature*, 48(1), pp. 353—354, June 26th, 1920. *Technical Review*, 6, p. 788, September 28th, 1920—Abstract.)

Different arrangements of small generators attached to a bicycle frame are described and illustrated for use in connection with small trench wireless sets.

1559. J. J. Graf. Radio Communication to and from Trains. (*Radio Amateur News*, 1, pp. 398—399, February, 1920.)

Some of the apparatus used is described and illustrated.

1560. W. J. Henry. The Pries Loop Set : III. Receiver. (*Radio Amateur News*, 1, p. 406, February, 1920 ; p. 502, April, 1920, and p. 610, May, 1920.)

1561. E. Nesper. The Progress and Development of Wireless in the World War. (*Jahrbuch Zeitschrift für drahtlose Telegraphie*, 15, p. 486, June, 1920. Abstracted from *Elektrotechnik und Maschinenbau*, 37, pp. 137—152, 1919.)

1562. E. J. Nally. Review of Radiotelegraphy. (*Telegraph and Telephone Age*, 38, pp. 648—649, December 16th, 1920.)

1563. The French Colonial Radio Stations. (*La Nature*, 48 (2), Supplement pp. 169—170, November 27th, 1920.)

Short notes with regard to the construction of the colonial stations.

1564. Wireless Telegraphy in China. (*Electrical Review*, 87, p. 80, July 16th, 1920.)

A note with regard to new stations to be erected.

1565. New Poulsen Radio Station. (*Telegraph and Telephone Age*, 38, p. 553, October 16th, 1920.)

Reference is made to plans for the erection of a new radio station at Oregon by the Federal Telegraph Company (U.S.A.).

1566. Combined Wire and Wireless Telephones. (*Electrical Review*, 87, p. 274, August 27th, 1920.)

A note with regard to the linking of landline and wireless telephones via the Air Ministry's radio station at Croydon.

1567. New York Radio Central Station. (*Wireless Age*, 7, pp. 10—12, August, 1920. *Elektrotechnische Zeitschrift*, 41, p. 867, October, 1920—Abstract. *Electrical Review*, 87, pp. 478—479, October 8th, 1920.)

Further particulars are given with a bird's-eye view plan of the site for the large radio station to be erected on Long Island.*

1568. Thousand Word a Minute World Wide Radio Station. (*Wireless Age*, 7, p. 7, July, 1920. *Technical Review*, 7, p. 30, October 12th, 1920—Abstract.)

Further particulars of the station referred to in RADIO REVIEW Abstract No. 1300, December, 1920.

Spark Transmitting Apparatus.

1569. C. F. Cairnes. Comparative Efficiency of High and Low Spark Frequencies. (*Everyday Engineering Magazine*, 9, pp. 61—62, April, 1920.)

Some results of test measurements are given.

1570. Design Features of the S.C.R. 112. (*Everyday Engineering Magazine*, 9, pp. 68—86, April, 1920.)

An illustrated description of a portable buzzer transmitter.

* See RADIO REVIEW Abstract No. 1300, December, 1920.

1571. Radio Equipment for Small Boats. (*Everyday Engineering Magazine*, 9, pp. 348—350, July, 1920.)

Installations manufactured by the **Wireless Speciality Company**, by **Cutting and Washington Radio Corporation** and by the **Radio Corporation of America** are described and illustrated.

1572. A New Hytone Transmitter. (*Everyday Engineering Magazine*, 9, p. 352, July, 1920.)

A short illustrated description of a $\frac{1}{2}$ kW transmitter manufactured by the **Clapp-Eastham Company**.

1573. **Gesellschaft für drahtlose Telegraphie**. Quenched Spark Transmitter. (*German Patent*, 308422, March 7th, 1917, relating to Patent 298451. Patent granted September 6th, 1919. *Jahrbuch Zeitschrift für drahtlose Telegraphie*, 16, pp. 90—91, January, 1920—Abstract.)

A method of producing a pure spark note in the ordinary type of quenched spark transmitter with A.C. supply by the introduction of a subsidiary alternating current of higher period in the supply circuit.

1574. **M. Deutsch**. Spark Transmitter. (*French Patent* 494019, December 20th, 1918. Published August 28th, 1919.)

The apparatus for producing high-frequency oscillations is of the kind comprising a make and break device shunted by an oscillatory circuit. A tap connection is provided to an intermediate point of an electro-magnet coil, so that when an alternating current supply is used only part of the coil is in circuit.*

1575. **D. R. Clemons**. Description and Design of a Small Transmitting Unit. (*Wireless Age*, 8, pp. 25—27, October, 1920.)

A panel type of apparatus is described using a buzzer for excitation.

1576. **E. T. Jones**. A Low Power Tuned Transmitter for Local Use. (*Wireless Age*, 7, p. 26, March, 1920.)

A simple form of tuned buzzer transmitter is described.

1577. **J. Pignone**. A Low Power Set. (*Wireless Age*, 7, pp. 41—43, June, 1920.)

A panel type of set is described and illustrated.

1578. **Société Française Radio-Électrique**. Continuous Wave Transmitter. (*French Patent* 502323, June 25th, 1915. Published May 11th, 1920.)

The invention comprises two spark gaps connected in series. Each spark gap is formed by a tube and a disc disposed eccentrically therein at one end. The tubes are arranged on a common axis and are connected to an air-blower and similarly the two discs are mounted on a common axis. The discs are moved in an epicycloidal path about the common axis of the tube.

1579. **J. Bethenod and E. Girardeau**. Improvements in Spark Gaps for Radiotelegraphy. (*French Patent* 476324, October 15th, 1914. *La T.S.F. Moderne*, 1, pp. 279—281, November, 1920—Abstract.)

This specification describes arrangements for operating spark gaps in parallel, the discharge currents being divided equally between them by means of the reactions between appropriate coupling coils joined in series with each spark gap.

Arc Apparatus.

1580. **C. Lorenz Aktien-Gesellschaft**. Oscillation Generator. (*French Patent* 504887, October 14th, 1919. Published July 19th, 1920.)

The specification refers more particularly to the production of electric oscillations by means of an electric arc and irregularities are prevented by the use of a large inductance in the high frequency circuit.

See also *British Patent* 132799—**RADIO REVIEW** Abstract No. 217, March, 1920.

1581. **M. Osnos**. The Production of High-frequency Currents by Arcs and Cathode Tubes. (*Jahrbuch Zeitschrift für drahtlose Telegraphie*, 15, pp. 487—488, June, 1920. Abstracted from *Elektrotechnik und Maschinenbau*, 37, p. 557, 1919.)

* See also *British Patent* 137564—**RADIO REVIEW** Abstract No. 880, October, 1920.

1582. **J. B. Dow.** The Design of a 1 kW Arc Converter. (*Radio Amateur News*, 1, pp. 472—474, March, 1920.)
Full details and working drawings are given.

High-frequency Alternators.

1583. **O. Billeux.** Continuous Wave Transmitter. (*French Patent* 498164, November 22nd, 1917. Published December 31st, 1919.)

This specification describes a high-frequency inductor alternator which has an unwound rotor consisting of two discs oppositely rotating at equal speeds and having magnetic teeth tangentially laminated and separated and retained by non-magnetic teeth.*

1584. **M. Latour.** High Frequency Alternator. (*French Patent* 502440, September 7th, 1915. Published May 14th, 1920.)

The invention relates to a high frequency homopolar alternator in which the number of polar projections on the rotor is greater than that on the stator, in such manner that if $2m$ is the number of slots on the stator, the number of polar projections on the rotor is $(2n + 1)m$.

1585. **Ziehl-Abegg Electricitäts-Gesellschaft and M. Osnos.** Polyphase Machines of the Inductor Type. (*German Patent* 317552, October 4th, 1918. Patent granted December 24th, 1919. *Jahrbuch Zeitschrift für drahtlose Telegraphie*, 15, p. 501, June, 1920—Abstract.)

A polyphase machine of the inductor type particularly suitable for high frequencies in which the ratio of tooth-space to tooth-breadth is equal or nearly equal to the phase number of the machine.

1586. **Société Française pour l'Exploitation des procédés Thomson-Houston.** Continuous Wave Transmitter. (*French Patent* 505959, November 12th, 1919. Published August 11th, 1920.)

The specification describes the Alexanderson high-frequency alternator in which the inductor is provided with two circumferential rows of radial slots filled with non-magnetic material such as copper. See also *British Patent* 134830.†

Static Frequency Raisers.

1587. **J. Jonas.** Static Frequency Changers. (*Jahrbuch Zeitschrift für drahtlose Telegraphie*, 15, pp. 481—482, June, 1920. Abstracted from *Elektrotechnik und Maschinenbau*, 33, pp. 17—32, 1915.)

1588. **M. Osnos.** On the Theory and Operation of Static Frequency Doublers. (*Jahrbuch Zeitschrift für drahtlose Telegraphie*, 15, pp. 485—486, June, 1920. Abstracted from *Elektrotechnik und Maschinenbau*, 37, p. 45, 1919.)

1589. **J. Bethenod and E. Girardeau.** Frequency Multiplier. (*French Patent* 502200, filed May 28th, 1915. Dated May 6th, 1920.)

This specification describes arrangements for multiplying the frequency of an alternating current by means of static transformers. The alternator is connected to two inductances having iron cores and furnished with a continuous saturation current provided by a battery. Reactances are connected in the battery circuit to prevent the passage of the alternating current therethrough and an inductance and capacity in parallel are placed in the alternator circuit, and another inductance and capacity in parallel are connected in one of the supply wires from which the current of increased frequency is taken.

1590. **L. Moldenhauer.** Frequency Multipliers using Saturated Iron. (*Elektrotechnische Zeitschrift*, 41, p. 837, October, 1920.)

A brief reference to his Doctor-thesis on this subject.

* See also *British Patent* 140769—RADIO REVIEW Abstract No. 780, September, 1920.

† RADIO REVIEW Abstract No. 336, May, 1920.

Thermionic Valve Apparatus (and special Applications).

1591. **A. Hund.** A New System of Wireless Telegraphy. (*Jahrbuch Zeitschrift für drahtlose Telegraphie*, 15, p. 481, June, 1920. Abstracted from *Elektrotechnik und Maschinenbau*, 33, p. 529, 1915.)
1592. **M. Gutton.** On Three-electrode Valves and Recent Progress in Wireless Telephony. (*Annales des Postes, Télégraphes et Téléphones*, 9, pp. 208—228, June, 1920.)
A general résumé of the various modes of use of a three-electrode valve followed by a consideration of its employment as a radio telephone transmitter and modulator.
1593. **A. S. Blatterman.** Regeneration and Oscillation in Vacuum Tube Circuits through Inter-electrode Tube Capacity. (*Technical Review*, 7, p. 357, December 14th, 1920.)
See RADIO REVIEW, 1, pp. 633—643, October, 1920.
1594. **M. A. Schirmann.** Calculation of Voltage Ratio of Triode with Double Grid. (*Annalen der Physik*, 62, pp. 97—106, May 28th, 1920.)
The problem is solved as a simple problem in electrostatics, *i.e.*, neglecting space charge.
1595. **W. Bragg.** Electrons. (*Electrical Review*, 88, pp. 125—127, January, 1921; pp. 156—157, February 4th, 1921. *Electrician*, 86, pp. 125—126, January 28th, 1921.)
Abstract of lecture given at the Institution of Electrical Engineers summarising our knowledge with regard to electrons and their properties.
1596. **G. Jaffé.** The Theory of High Vacuum Discharges. (*Annalen der Physik*, 63, pp. 145—174, September 28th, 1920.)
A theoretical extension of the ordinary space-charge problem to the case of an appreciable amount of residual gas and consequent presence of positive ions. The effect of a positive potential gradient at the cathode is also investigated. The results are compared with some experimental results obtained by Lilienfeld.
The paper is followed (pp. 175—178) by a communication from Lilienfeld in which he discusses the discrepancies between his experimental results and Jaffé's theory.
1597. **F. L. Hopwood.** A Demonstration of Experiments on the Thermionic Properties of Hot Filaments. (*Proceedings of the Physical Society of London*, 32, p. 244, June 15th, 1920.)
1598. **Siemens and Halske Aktien-Gesellschaft.** Valve Construction. (*French Patent* 505897, November 10th, 1919. Published August 9th, 1920.)
Two intermediate electrodes are interposed between a cathode filament and an anode. One electrode consists of a zigzag wire or net placed between two layers of wire forming the other electrode.
See also *British Patent* 134542—RADIO REVIEW Abstract No. 796, September, 1920.
1599. A Radiotelephone Operating at Six Volts. (*Everyday Engineering Magazine*, 9, p. 445, August, 1920.)
A short illustrated description of a radio telephone transmitter using an oscillating valve supplied from a buzzer-operated step-up transformer through two rectifying valves.
1600. **M. B. Sleeper.** English Radio Equipment. (*Everyday Engineering Magazine*, 9, pp. 540—541, September, 1920.)
An illustrated description of a $\frac{1}{2}$ kW and a $1\frac{1}{2}$ kW valve apparatus manufactured by Marconi's Wireless Telegraph Company.
1601. **F. Duroquer.** The Construction of a C.W. Transmitter and of a Radio Telephone Transmitter. (*La Nature*, 48(2), Supplement pp. 179—180, December 4th, 1920.)
1602. **J. Scott-Taggart and J. Ree.** An Ordinary Triode used as a Negative Resistance Oscillator. (*Electrical Review*, 87, p. 602, November 5th, 1920—Abstract. *Technical Review*, 8, p. 47, January 11th, 1921—Abstract.)
The authors describe the use of an ordinary pattern of triode as a negative resistance oscillator arranged on the lines of the Dynatron.

1603. **H. H. Poole.** On the Use of Vector Methods in the Derivation of the Formulæ used in Inductance and Capacity Resonance. (*Philosophical Magazine*, 40, pp. 793—809, December, 1920.)

The equations relating to well-known methods of measuring capacity and inductances are derived directly from the vector diagrams of the bridge networks.

1604. **W. Seltz.** The Efficiency of Various Transmitting Valve Connections. (*Jahrbuch Zeitschrift für drahtlose Telegraphie*, 15, pp. 457—460, June, 1920.)

Two different systems were tried, one with the ordinary back-coupling, and the other with an auxiliary oscillatory valve controlling the grid of the main valve. In addition to determining the efficiency in the usual way, a thermojunction was welded to the copper anode and calibrated by passing known currents through the tube without oscillations. In this way the power wasted in heating the anode was determined. With back-coupling the efficiency varied from 57 per cent. at 500 metres to 72 per cent. at 2,000 metres, whilst with the auxiliary excitation it varied from 52 per cent. at 500 metres to 78 per cent. at 1,600 metres.

1605. **W. Seltz.** On the Discontinuous Resonance Curves of Triode Oscillators. (*Jahrbuch Zeitschrift für drahtlose Telegraphie*, 15, pp. 460—469, June, 1920. *Science Abstracts*, 23B, p. 445, Abstract No. 847, September 30th, 1920—Abstract. *Technical Review*, 7, p. 323, December 7th, 1920—Abstract.)

An experimental paper giving a number of resonance curves obtained with an ordinary triode with back coupling between the oscillatory circuit in the anode circuit and a coil in the grid circuit: a separate oscillatory circuit, representing an aerial, is coupled with the anode circuit and the curves are plotted for various values of the capacity in this latter circuit. Curves are given for a large number of cases to show the effects of the various inductances, resistances, coupling coefficients, etc.

1606. **G. Preuner and L. Pungs.** Calorimetric Determination of Efficiency of Triode Generators. (*Jahrbuch Zeitschrift für drahtlose Telegraphie*, 15, pp. 469—479, June, 1920. *Science Abstracts*, 23B, p. 443, Abstract No. 842, September 30th, 1920—Abstract. *Technical Review*, 7, p. 290, November 30th, 1920—Abstract.)

The authors inserted the triode in a calorimeter filled with paraffin oil, which they calibrated with an electric heater. A glass vessel was used to prevent eddy current loss in the vessel itself, the glass vessel being painted black and provided with a cover of vulcanised fibre. A comparison of the energy as measured electrically and thermally with a D.C. heater showed agreement within 1 per cent. The efficiency of the triode generator was also determined by an optical method depending on the observed glow of the anode. This was adjusted to the same temperature when the circuit was not oscillating, the whole energy supply in this case being used to heat the anode. The efficiencies obtained varied from 57 to 70 per cent.

1607. **G. A. Beauvals.** Valve Construction. (*French Patent* 503641, August 4th, 1917. Published June 15th, 1920.)

To prevent the deposition of metallic films between the supports for the electrodes, screens, for example of glass, are arranged within the tube. See also *British Patent* 130040.*

1608. **G. A. Beauvals.** Valve Construction. (*French Patent* 503611, August 1st, 1917. Published June 15th, 1920.)

The grid electrode is heated by the passage of a current and the plate electrode by electronic bombardment from the grid, during the exhaustion of the tube. See also *British Patent* 130039.†

1609. **Société J. Bœuze & Cie.** Valve Construction. (*French Patent* 503206, February 22nd, 1917. Published June 5th, 1920.)

The object of the invention is to give a greater rigidity to the grid in valves, the grid being formed by a metal wire wound into a helix. One method consists in placing between the spirals of the grid a wire also wound into a helix of very small diameter and passing alternately under and over each of the grid spirals. Other methods are also described.

* RADIO REVIEW Abstract No. 37, November, 1919.

† RADIO REVIEW Abstract No. 36, November, 1919.

1610. **K. Rottgardt and A. Meissner.** Three-electrode Oscillation Generator. (*Elektrotechnische Zeitschrift*, 41, pp. 902—903, November 11th, 1920.)

The former writes objecting to the name "Telefunken cathode tube generator," but the latter replies that the priority of the Telefunken Company in this device is acknowledged in all countries and that it is important at the present juncture to emphasise the German origin of such inventions.

1611. **A. H. Wood.** A Laboratory Radiophone. (*Wireless Age*, 7, pp. 27—28, September, 1920.)

A description of the instrument is given with data for constructional purposes.

1612. **C. R. White.** A Small Radiophone Transmitter. (*Wireless Age*, 7, p. 27, June, 1920.)

Constructional details and dimensions are given for a small panel transmitter using two receiving valves as oscillation generators.

1613. **C. R. Lutz.** A Twenty-five Mile Radiophone Transmitter for 200 Metre Work. (*Wireless Age*, 7, pp. 15—18, April, 1920.)

Constructional details are given.

1614. **M. Latour.** Continuous Wave Generator. (*French Patent* 502601, August 16th, 1915. Published May 21st, 1920.)

The specification describes the excitation of the plate circuit of a vacuum tube generator by a source of alternating current of musical frequency, the object being to permit the reception of continuous waves with an ordinary receiving arrangement, the filament being heated by the same source of alternating current.

1615. **Compagnie Française pour l'Exploitation des Procédés Thomson-Houston.** Continuous Wave Transmitter. (*French Patent* 497446, March 22nd, 1919. Published December 5th, 1919.)

The specification describes an oscillation generating system employing a vacuum tube. For further particulars see *British Patent* 139640.*

1616. **Compagnie Française pour l'Exploitation des Procédés Thomson-Houston.** Continuous Wave Transmitter. (*French Patent* 501320, May 10th, 1919. Published April 9th, 1920.)

The specification describes a transmitting apparatus employing modulated continuous waves in which the aerial is tuned to a frequency equal to the sum or difference of the wave frequency and the modulated or amplitude pulsation frequency, and the circuit of the source of oscillations is tuned to the wave frequency, or the frequency of the source, with the object of keeping the current supplied by the source in phase with the electromotive force. See also *British Patent* 130369.†

1617. **G. A. Beauvals.** Transmitting System. (*French Patent* 503942, December 14th, 1917. Published June 21st, 1920.‡)

The specification describes a system for producing electric oscillations of the kind employing a three-electrode valve. A resistance shunted by a condenser is placed in the grid circuit of the valve and the potential at the terminals of the resistance is varied by the action of a microphone or an independent oscillating circuit.

1618. **R. F. Gowen.** A Modern Radio Telephone. (*Radio Amateur News*, 1, pp. 536—538, April, 1920.)

1619. **Captain Metz.** French Applications of the Momentous Vacuum Tube. (*Radio Amateur News*, 1, pp. 608—609, May, 1920; pp. 678—680, June, 1920.)

1620. **J. Goussin.** French Vacuum Tube Instruments. (*Radio News*, 2, p. 73, August, 1920.)

1621. **T. Brown.** Improved Vacuum Tube Circuits for Short Wave Communication. (*Radio News*, 2, pp. 212—213, October, 1920.)

In the transmitting circuit described two oscillating valves are inductively coupled to the

* RADIO REVIEW Abstract No. 883, October, 1920.

† RADIO REVIEW Abstract No. 128, January, 1920.

‡ See also *British Patent* 131018—RADIO REVIEW Abstract No. 129, January, 1920.

aerial, and for the receiver filtering circuits are used in the anode of the detecting valve. It is claimed that stability of the beat frequency is obtained by this means when using wave lengths of the order of 150—200 metres.

1622. **J. Haas.** A Novel Radiophone. (*The Radio Amateur*, 2, p. 12, March, 1920.)

In the circuit diagrams a single valve is shown as employed both for transmission and reception without change-over switches, the receiving telephones being joined in its plate circuit and the transmitting microphone in the earth lead.

1623. **J. Scott-Taggart.** Two Laboratory Functions of the Triode Valve. (*Electrician*, 86, p. 124, January 28th, 1921.)

For the measurement of high voltages whether direct or alternating it is proposed to connect a three-electrode valve across the voltage to be measured and to increase the negative voltage applied to the grid of the valve until the plate current falls to zero. The negative voltage on the grid is taken as a measure of the voltage in the anode circuit. Any leakage in a high insulation may be detected by inserting the insulation in the grid circuit of a valve with a negative voltage in series with it and noting any change in the anode current when the insulation is connected up.

1624. **J. Scott-Taggart.** A Double Anode Vacuum Tube, A.C. Rectifier and Wireless Transmitter. (*Electrical Review*, 87, p. 298, September 3rd, 1920.)

A vacuum tube provided with two anodes is described together with its uses for rectifying by using one tube only both halfwaves of an A.C. supply. The same apparatus with the addition of a single grid electrode surrounding the filament may also be employed for wireless transmission with an A.C. supply arranged as in Fig. 1, where T is the step-up transformer, V is the special double anode valve with grid and C_1 and C_2 are two condensers to by-pass high-frequency currents round the power transformer. Almost the whole of the A.C. ripple may be eliminated by this means.

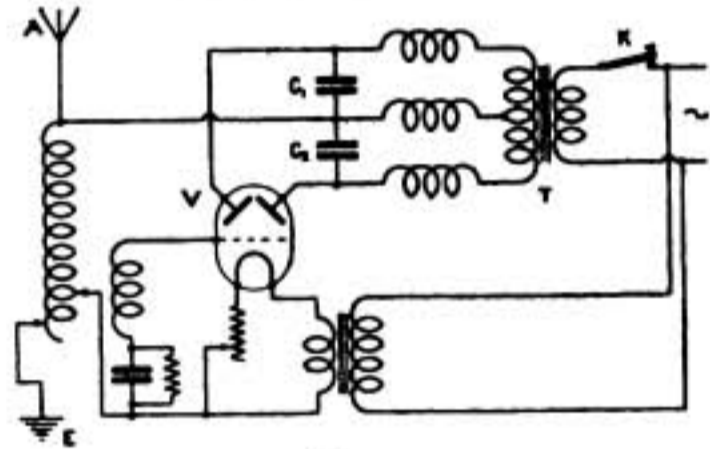

FIG. 1.

1625. **C. Loog.** Gas-filled Glow Discharge Rectifiers in the Telegraph and Telephone Service. (*Telegraphen- und Fernsprech-Technik*, 9, pp. 105—107, September; pp. 123—126, October, 1920.)

Description of bulbs containing neon, helium or argon at pressures of 3 to 10 mm by means of which the 220-volt A.C. supply can be used instead of batteries for microphone and other circuits.

1626. A Vacuum Tube with External Anode. (*Annales des Postes, Télégraphes et Téléphones*, 9, pp. 320—327, June, 1920. *La Nature*, 48(2), Supplement pp. 159—160, September 4th, 1920—Abstract.)

A résumé of an article published in the *Electrical World* in June, 1919, outlining experiments of three-element vacuum tubes having the anode outside the glass.* Characteristic and other curves of the tube are given.

1627. **R. Whiddington.** The Ultra-Micrometer; an Application of the Thermionic Valve to the Measurement of very small Distances. (*Philosophical Magazine*, 40, pp. 634—639, November, 1920. See also *Engineering*, 110, p. 384, September 17th, 1920; *Science Abstracts*, 23A, p. 537, Abstract No. 1350, November 30th, 1920—Abstract. *L'Elettrotecnica*, 7, p. 636, December 15th, 1920.)

In all interferometer methods of measuring small distances the accuracy of measurement is limited by the wavelength of the light used. An arrangement described in this paper is not subject to this limitation. Two oscillating valve circuits are employed one of which maintains a steady high frequency oscillation. The condenser in the oscillation circuit of the second valve is formed by two parallel metal plates, the movement of one of which is to be

* Of the type devised by P. Donle.

measured. By the inter-action between the two circuits beats are produced in a loud speaking telephone connected by an amplifier to one of the oscillating valves. The constancy of the beat tone is secured by comparison with an audible frequency note set up by a third oscillating valve. It is shown that changes as small as one two-hundred-millionth of an inch can easily be detected. A simpler method of using the apparatus is described for the measurement of movements of the order of a one-hundred-thousandth of an inch.

1628. **J. A. Eyster.** An Audio-frequency Vacuum Tube Generator. (*Journal of the American Institute of Electrical Engineers*, 39, pp. 888—889, October, 1920. *Science Abstracts*, 23B, pp. 569—570, Abstract No. 1085, December 30th, 1920—Abstract.)

The author describes the development of a vacuum tube alternating current generator particularly for use in A.C. bridge measurements where a pure sine wave current is required. The complete apparatus is illustrated and constructional details are given.

1629. **R. T. Beatty and A. Gilmour.** On the Measurement of Changes in Resistance by a Valve Method. (*Philosophical Magazine*, 40, pp. 291—295, September, 1920.)

The resistance to be measured is included in the grid circuit of an oscillating valve and is shunted by a small condenser. Curves are given connecting the resistance in ohms with the frequency of the oscillations for different values of the capacity. Measurements are made by observation of the silence points which occur for particular adjustments of the resistance. The method may also be applied to the comparison of the capacities of condensers from a few centimetres to about $1\mu\text{F}$.

1630. **H. Abraham, E. Bloch and L. Bloch.** Direct Reading Apparatus for the Measurement of Alternating Currents; the Amplifying Voltmeter. (*Journal de Physique et la Radium*, 1, pp. 44—57, August, 1920.) Also **H. Abraham.** (*Annales des Postes, Télégraphes et Téléphones*, 9, pp. 197—207, June, 1920. *Bulletin de la Société Belge des Électriciens*, 34, pp. 245—246, October, 1920—Abstract.)

After a brief introduction on the triode tube and its use as an oscillation generator, detector and amplifier the author's amplifying voltmeter is described following the general lines of a previous paper.* Some of the applications of the apparatus are briefly referred to.

Transmitter Control or Modulation.

1631. **L. F. Fuller.** New Arc Method for Continuous Waves. (*Wireless Age*, 8, p. 19, November, 1920. *Science Abstracts*, 23B, p. 582, Abstract No. 1114, December 30th, 1920—Abstract.)

The article outlines the signalling method described in *British Patent* 131561.†

1632. **P. J. Laüt.** Continuous Wave Transmitter. (*French Patent* 505328, October 23rd, 1919. Published July 28th, 1920.)

The system described is an arc generator system with the sending key inserted in the antenna circuit. An auxiliary circuit having a short wavelength is connected across the arc to prevent its extinction when the antenna circuit is interrupted. The capacity in the shunt circuit is made approximately the same as the antenna capacity.

There is a corresponding *British Application* No. 152970, the patent on which has not yet been granted.

Books Received.

LONGUEURS D'ONDE ET PROPAGATION. By M. Vieillard. (Paris: *Gautier-Villars et Cie.* 1921. $10 \times 6\frac{1}{2}$ ins. Pp. xii + 416. Price not stated.)

JOURNAL AND RECORD OF TRANSACTIONS OF THE JUNIOR INSTITUTION OF ENGINEERS. Edited by W. A. Tookey. (London: *Percival Marshall & Co.* Vol. 30. 1920. $8 \times 5\frac{1}{2}$ ins. Pp. vi + 408 + cx. Price 15s.)

WIRELESS TELEGRAPHY: WITH SPECIAL REFERENCE TO THE QUENCHED SPARK SYSTEM. By B. Leggett, A.M.I.E.E. (London: *Chapman and Hall, Ltd.* 1921. $8\frac{1}{2} \times 5\frac{1}{4}$ ins. Pp. xv + 485. Price 30s. net.)

* RADIO REVIEW Abstract No. 1415, January, 1921.

† See RADIO REVIEW Abstract No. 189, February, 1920.

Correspondence.

INDUCTANCE CALCULATIONS.

TO THE EDITOR OF THE "RADIO REVIEW."

SIR,—From time to time formulæ and tables have been published in the RADIO REVIEW with a view to facilitating the calculating of inductances of air-coil solenoids.

In this connection, details of a special calculator of slide rule form which I devised some years ago may be of interest.

The calculator is constructed on the basis of Professor Nagaoka's well-known formula for single-layer coils, namely :—

$$L = \pi^2 d^2 n^2 l k$$

where d = diameter in cms

n = turns/cm

l = length in cms

and k is a function of l/d

The formula may be re-written :—

$$L = d^3 n^2 \left(\pi^2 \frac{l}{d} \cdot k \right) \\ = d^3 n^2 P$$

where P is also a function of l/d .

The calculator is therefore constructed with scales corresponding to :—

$\log L$

$\log d^3$

$\log n^2$

$\log P$ where $P = f(l/d)$.

The last scale while being spaced out according to $\log P$ is engraved in terms of l/d .

Referring to the photograph it will be seen that the actual rule is arranged with the P scale

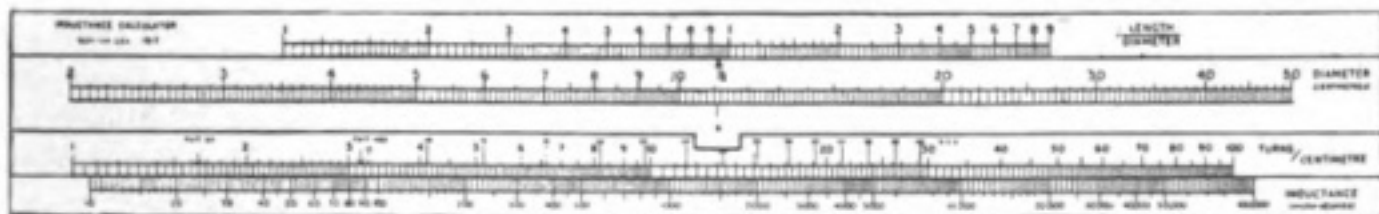

at the top and that the limits within which the rule will operate are respectively :—

l/d	0.1 to 9
Diameter	2 to 50 cms
Turn/cm	1 to 100
Inductance	10 to 100,000 microhenries

which are sufficient for most purposes.

The scale of "turns per centimetre" has marks on it corresponding to the various gauges and coverings of wire, which is found to be a very useful arrangement, but these markings must be used with caution owing to possible variations in space factor with the method of winding.

An accuracy of 1 to 2 per cent. in the calculated inductance value is usually obtained and

the errors arising when the calculator is used for multi-layer coils are small enough to be neglected, at any rate as a first approximation.

Radio Communication Co., Ltd.,
London, *January 25th*, 1921.

NORMAN LEA.

MICA CONDENSERS FOR RADIO WORK.

TO THE EDITOR OF THE "RADIO REVIEW."

SIR,—We have noted in the December, 1920, issue of the RADIO REVIEW, the article entitled "Mica Condensers for Radio Work," on page 768. In reading this article one is led to believe that the Wireless Specialty Apparatus Company is no longer in the mica condenser business, and has been an infringer, rather than an important contributor in the development of the mica condenser. The Wireless Specialty Apparatus Company are now, and have been, very actively engaged in this business and its development, and have established an enviable reputation as the designers and manufacturers of the Faradon condensers. We are giving here a short review of the suit brought against the Wireless Specialty Apparatus Company by the Dubilier Condenser Company, and of the important part we have played in the development of mica condensers.

The following facts concerning mica condensers will be of interest to your readers supplementing those stated in your article of December, 1920. The first article was incomplete in that it did not include mention of the facts involving the Wireless Specialty Apparatus Company in the situation in such way as to bring out the fact that it is now the only company having the right to manufacture the efficient modern form of high voltage mica condenser, as hereinafter described, and our thought is that you will be glad to avail yourself of the additional facts submitted below which will correct any false impression which the first article might convey contrary to the facts.

It might appear to the uninitiated that it would have been impossible during recent years to improve materially on the series sectional mica condensers for high potential and radio service which previously had been used for a considerable period, especially in the United States Navy Radio Service. While it is quite true that those earlier condensers had employed a series sectional feature, yet in view of the much greater success attendant upon the introduction in more recent years of the modern form of the series sectional type, it is not surprising to learn the fact that this condenser embodies in part ideas disclosed in the Dubilier patents and applications which are of very vital novelty and in part ideas originating with the Messrs. Pickard and Priess of the Wireless Specialty Apparatus Company, and other employees of the company, and embodied in the present form of highly efficient mica condenser as now manufactured by our company for transmitting, receiving, and power factor work, each feature working together with the feature of sectionalising to the result of a high efficiency and small volume.

The ideas shown in more or less undeveloped form in the Dubilier patents were developed by the Wireless Specialty Apparatus Company, at the request of the United States during the war emergency, in combination with its own inventions, with the result of producing what the trade now recognises as the modern type of mica condenser, known as the Faradon.

The features originated by Wireless Specialty Apparatus Company include matters of construction and of processes of manufacture substantially as follows.

At the outset of its condenser work, the Wireless Specialty Apparatus Company developed accurate methods of measuring the comparatively low losses found in mica condensers, employing these methods the company's engineers were enabled to logically investigate the causes of and reduce to a minimum such losses as—

- (a) Dielectric losses due to the quality of mica.
- (b) Composite dielectric of the mica and the filler.
- (c) Filler losses due to the dielectric hysteresis of the particular fillers in use and the homogeneity of the filler.
- (d) Brush losses due to non-homogeneity of the filler, imperfect contact between conducting elements in the condenser and the mica.
- (e) Value of dielectric strain per unit thickness of mica in a section.
- (f) The ohmic loss in condenser conductors.

(g) Effective leakage resistance of the condenser.

(b) Poor thermal conductivity between the condenser stack and the radiating members.

The company then proceeded to develop practicable embodiments to maintain in the completed condenser the high degree of efficiency developed in their condenser research.

Several very important methods were developed which co-operated to select the quality of mica necessary for producing the condenser of the high order of efficiency of the United States Naval Laboratories. Manufacturing processes were developed to produce substantially perfect contact between the conducting and mica elements in the condensers. A filler was developed of low dielectric loss, high dielectric strength, and a high thermal conductivity, chemically stable under conditions of high dielectric stress, and wide changes in temperature. The best form and material for the conducting elements, the correct sectional voltage for different thicknesses of mica, and the best sheet margins were determined.



Types of "Faradon" Condensers, showing the Method of Construction.

Manufacturing methods were developed for embedding the condenser within the casing in a holosteric filler, *i.e.*, a filler free from voids, and homogeneous. The leakage resistance from the high potential terminal to the casing within the casing was made practically infinite by obtaining intimate contact between the filler and the casing at the high potential end of the condenser. A manufacturing method was developed for obtaining intimate contact between the conducting elements and the mica sheets, excluding composite insulation to the highest practicable degree.

Designs were developed for taking care of the loss developed in the condenser by providing a very good thermal path between the stack and the casing. The casing was designed with a maximum radiation surface for transferring this heat to the surrounding air. A radiating

member was added to the high potential terminal to assist in reducing the temperature of the sections of the condenser nearest the high potential terminal. In some designs, maximum thermal conductivity from the stack to the casing, *via* the stack axis, was obtained by placing two or more series section stacks electrically in parallel in the casing and having one surface of each of the stacks in contact with the casing and connected to it. This design produced a condenser of low cost due to the use of comparatively small area sheets of mica and having the thermal conductivity of a condenser of much higher cost, based on the use of mica sheets of area equivalent to the sum of the areas of sheets in contact with the casing. The spacing between the condenser stack and the casing was determined so that the dielectric strength of any portion of the path between stack and casing possessed a voltage safety factor equal to that of the stack, thereby producing a condenser having a minimum of filler and therefore a maximum of thermal conductivity between the stack and the casing *via* the filler.

Many designs were evolved. The pressure on the stack sufficient to maintain the intimate contact produced in the process of manufacture was retained in the final condenser, by novel clamping means developed by the company's engineers. For some classes of service, the clamping means was made elastic, vanadium steel in general being used as the spring members. These springs retain pressures of the orders of a ton per square inch of the active area on the condenser stack and maintain this pressure over wide variations of temperature of the condenser unit. Through the above-mentioned designs and the result of careful research over several years, the Faradon condenser has been evolved. This condenser had a phase angle at 20° C. of approximately one minute and twenty seconds. The best condensers that we have tested previous to our designs measured in the neighbourhood of four minutes.

The above and other features originated by Wireless Specialty Apparatus Company are the subject of patent protection by a large number of applications for patents, and the company has not authorised any one to use them. Furthermore, as the result of the recent litigation in the United States courts under two Dubilier patents and involving the manufacture for and sales of condensers to the Government during the war by Wireless Specialty Apparatus Company, the latter company acquired exclusive commercial rights with the plaintiff, under the two Dubilier patents in suit and seven other Dubilier patents not involved in the suit, in addition to four Dubilier applications for patent. The Dubilier Company, however, did not receive any patent rights or licences from Wireless Specialty Apparatus Company. Furthermore, no one else has been authorised by the Wireless Specialty Apparatus Company to make, use or sell any of the inventions of any of its various patent applications, either with or without the inventions of the Dubilier patents, that is to make, use or sell the modern form of sectional mica condenser for high voltage use as known to the trade during the last few years.

I might add that the United States also received a licence to use the inventions of the Dubilier patents and applications as a result of the court's decree, although the United States did not receive any licences under the inventions of our company.

Inasmuch as you showed several photographs of Dubilier's condensers, it will be, no doubt, of interest to your readers to see the constructions of two of our standard types, photographs of which are enclosed for publication.

Very truly yours,
W. J. HENRY,
Production and Sales Manager.

Wireless Specialty Apparatus Company,
Boston, Mass., U.S.A.,
January 15th, 1921.

ERRATUM.

Page 76 (issue for February, 1921), Fig. 1. *The following caption should be added below the figure:—*

EFFECT OF AN IMPURITY ON THE IONISATION POTENTIAL OF HELIUM.

The curves A to E were taken at the following times after commencement of the tests:—
A = 0 minutes ; B = 30 minutes ; C = 430 minutes ; D = 550 minutes ; E = 730 minutes.

Fig. 2. *This diagram should be marked:—Aged 190 minutes.*